

NEW GENERATION

ART

STOSA  
CUCINE

Art collection III

**ART**

**NEW GENERATION**

**ART è progettata per dare una concreta soluzione a chi cerca qualità dei materiali e risposte a ogni esigenza estetica e funzionale a un prezzo accessibile.**

**ART propone modelli pensati per arredare cucina e living con il design distintivo che da sempre contraddistingue Stosa, coniugando affidabilità, estetica, flessibilità progettuale e competitività nel rapporto qualità prezzo.**

ART is designed to provide a practical solution for those seeking quality materials and answers to all stylistic and functional needs at an accessible price.  
ART models are designed to give kitchens and lounges that distinctive Stosa look – a combination of reliability, beauty, design flexibility and competitive quality-to-price ratio.

ART está proyectada para dar una solución concreta a quienes buscan materiales de calidad y una respuesta a toda exigencia estética y funcional a un precio asequible.  
ART propone modelos concebidos para decorar la cocina y el living con el diseño que siempre ha distinguido a Stosa, en un connubio de fiabilidad, estética, flexibilidad proyectiva y competitiva relación calidad-precio.

ART est conçue pour apporter une solution concrète aux personnes qui souhaitent des matériaux de qualité, mais aussi des réponses aux exigences esthétiques et fonctionnelles à un prix accessible.  
ART propose des modèles conçus pour aménager la cuisine et le living avec le design distinctif qui caractérise Stosa depuis toujours, en alliant fiabilité, esthétique, flexibilité de conception et compétitivité dans le rapport qualité/prix.





#### Le certificazioni FSC® E CARB 2

Nel 2012 Stosa Cucine ha sposato la certificazione del Forest Stewardship Council® (FSC) e oggi ha raggiunto l'obiettivo di offrire ai propri clienti prodotti realizzati di serie con materiale certificato. L'impegno che Stosa Cucine sta portando avanti è però quello di riprogettare forniture e linee di produzione, al fine di poter arrivare quanto prima a convertire tutti i modelli presenti in gamma in sistemi di cucina realizzati con legno certificato proveniente da una filiera che supporta la gestione forestale responsabile, senza maggiorazione del prezzo per l'acquirente finale. Tutti i mobili delle cucine Stosa utilizzano materiali certificati CARB P2. Le scocche sono ricavate da pannelli riciclabili e a bassissimo contenuto di formaldeide, a ulteriore conferma dell'attenzione dell'Azienda alla salvaguardia dell'ambiente e al risparmio delle risorse naturali. **Design e Innovazione non possono prescindere da una selezione di materie prime che sposi l'etica del riciclo e il rispetto ambientale.**

In 2012 Stosa Cucine joined the Forest Stewardship Council® (FSC) certification project. Today, we have achieved the goal of offering customers products that are made from certified materials. However, Stosa Cucine remains committed to further improving supply networks and production lines to convert, as soon as possible, all models in the range into furniture made from certified wood from a supply chain that supports responsible forest management, with no increase in price to customers.

The doors of Stosa kitchens are Carb P2 certified. This means they are made from fully recycled and recyclable material with extremely low formaldehyde emission. Carb P2 certification clearly demonstrates Stosa's commitment to protecting the environment and saving natural resources.

En 2012 Stosa Cucine adhirió a la certificación del Forest Stewardship Council® (FSC) y actualmente ha alcanzado el objetivo de ofrecer a sus clientes productos totalmente fabricados con materiales certificados. Sin embargo, el compromiso actual de Stosa Cucine consiste en renovar los sistemas de suministro y las líneas de producción con el objetivo de llegar a convertir a la brevedad todos los modelos de su gama en sistemas de cocina producidos con madera certificada procedente de una cadena de suministro que sostenga la gestión forestal responsable, sin aumentar por esto los precios para el consumidor final.

Les portes des cuisines Stosa sont certifiées Carb P2 : elles sont fabriquées uniquement avec des panneaux réalisés avec des matériaux complètement recyclés et recyclables, à très faible teneur en formaldéhyde, confirmant ainsi l'attention portée par l'Entreprise à la sauvegarde de l'environnement et à l'économie des ressources naturelles.

En 2012, Stosa Cucine a adopté la certification du Forest Stewardship Council® (FSC) et, aujourd'hui, elle a atteint l'objectif d'offrir à ses clients des produits réalisés avec des matériaux certifiés. Cependant, l'engagement poursuivi par Stosa Cucine est de reconcevoir des fournitures et des lignes de production, afin de convertir rapidement tous les modèles de notre gamme en systèmes de cuisine fabriqués avec du bois certifié provenant d'une filière issue d'une gestion forestière responsable, sans pour cela augmenter le prix pour l'acheteur final.

Las puertas de las cocinas Stosa cuentan con la certificación Carb P2: se obtienen de tableros de material completamente reciclado y reciclable, con infimo contenido de formaldehídos, a demostración de la atención que la empresa pone en la tutela del medio ambiente y en el ahorro de recursos naturales.



### Cosmob qualitas praemium. Circolarità del prodotto arredo

Stosa cucine si distingue per i risultati raggiunti negli ultimi anni in termini di impiego sostenibile delle risorse lungo l'intero ciclo di vita del prodotto. La percentuale di materiale che può essere riutilizzata si attesta su valori vicini al 100%.  
 Stosa Cucine stands out for the results achieved in recent years in terms of sustainable use of resources throughout the entire life cycle of the product. The percentage of material that can be reused is close to 100%.  
 Stosa Cucine destaca por los resultados obtenidos en los últimos años en cuanto al uso sostenible de los recursos a lo largo de todo el ciclo de vida del producto. El porcentaje de material que se puede reutilizar es cercano al 100%.  
 Stosa Cucine se distingue par les résultats obtenus ces dernières années en termes d'utilisation durable des ressources tout au long du cycle de vie du produit. Le pourcentage de matière pouvant être réutilisé est proche de 100%.

### Made in Italy

Disegno, progettazione, lavorazione e confezionamento delle cucine Stosa sono effettuati esclusivamente in territorio italiano.  
 Design, planning and processing are all performed entirely in Italy.  
 Los diseños, proyectos y trabajos se realizan todos en Italia.  
 Le dessin, la conception et la fabrication des produits sont entièrement effectués en Italie.



CIRCOLARITÀ DEL PRODOTTO ARREDO  
 Certificato n° 42/2021



### Certificazione di origine italiana del mobile

Stosa cucine rispetta tutti i requisiti previsti dalla norma UNI 11674. Le fasi rilevanti del processo di produzione dell'arredo avvengono in territorio italiano.  
 Stosa cucine complies with all the requirements of the UNI 11674 standard. The relevant phases of the furniture production process take place in Italy.  
 Stosa cucine cumple con todos los requisitos de la norma UNI 11674. Las fases relevantes del proceso de producción de muebles tienen lugar en Italia.  
 Stosa cucine est conforme à toutes les exigences de la norme UNI 11674. Les phases pertinentes du processus de production de meubles se déroulent en Italie.

### ISO 9001: 2015 Sistema di gestione qualità

Il sistema di gestione della qualità Stosa è orientato alla ricerca e all'innovazione di processi e prodotti.  
 Quality management system Stosa is focused on researching and innovating production processes.  
 Sistema de gestión de calidad de Stosa son la investigación y la innovación de procesos y productos.  
 Système de management de la qualité Stosa est orientée vers la recherche et l'innovation de processus et de produits.

### Italy's Best Customer Service

Il Customer Service di Stosa Cucine si aggiudica il posto più alto del podio nella classifica del Corriere Economia che ne valuta la qualità.  
 Stosa Cucine's Customer Service wins first prize for quality. The Corriere Economia daily has examined the leading brands of Italy's furniture industry.  
 El Servicio Clientes de Stosa Cucine se adjudica el primer puesto del podio en la clasificación del Corriere Economia sobre la calidad.  
 Le service client de Stosa Cucine occupe la plus haute marche du podium dans le classement du Corriere Economia qui en évalue la qualité.



### Strutture

carcasses / structures / estructuras

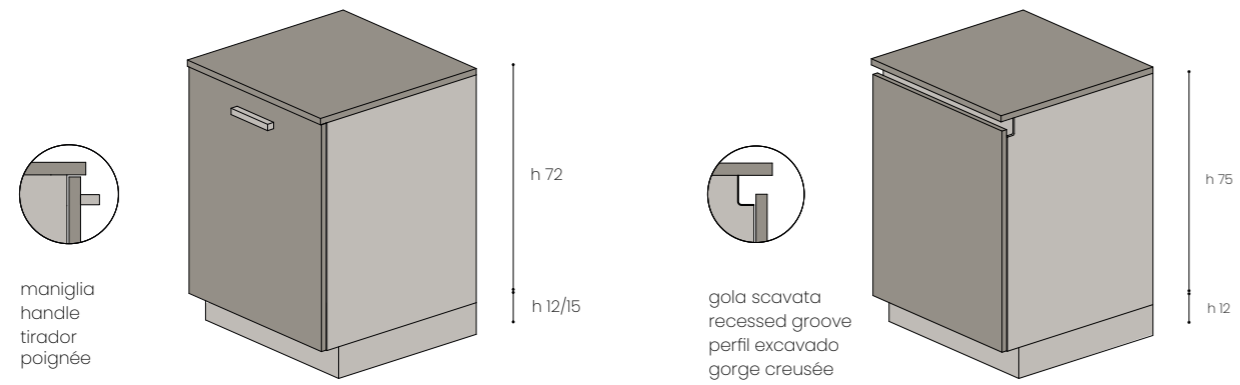

### Ante

doors / portes / puertas

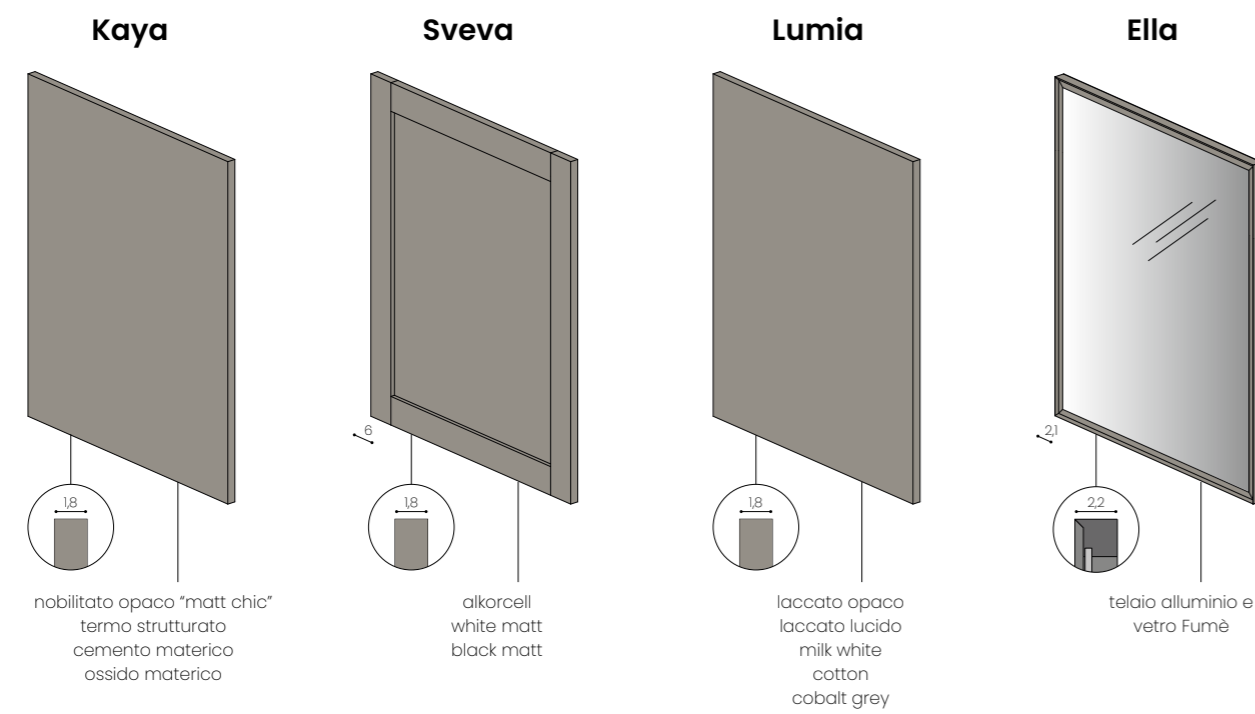

### Modularità con maniglia

handle modularity / modularidad con tirador / modularité avec poignée

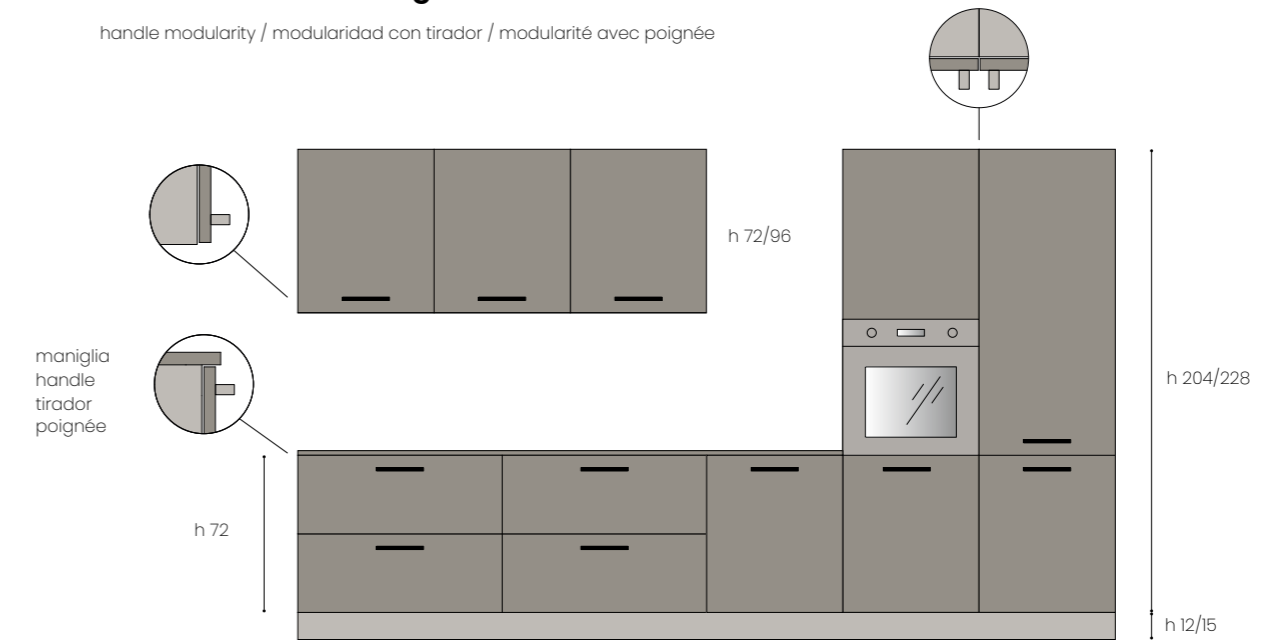

### Modularità con gola

groove modularity / modularidad con perfil excavado / modularité avec gorge creusée

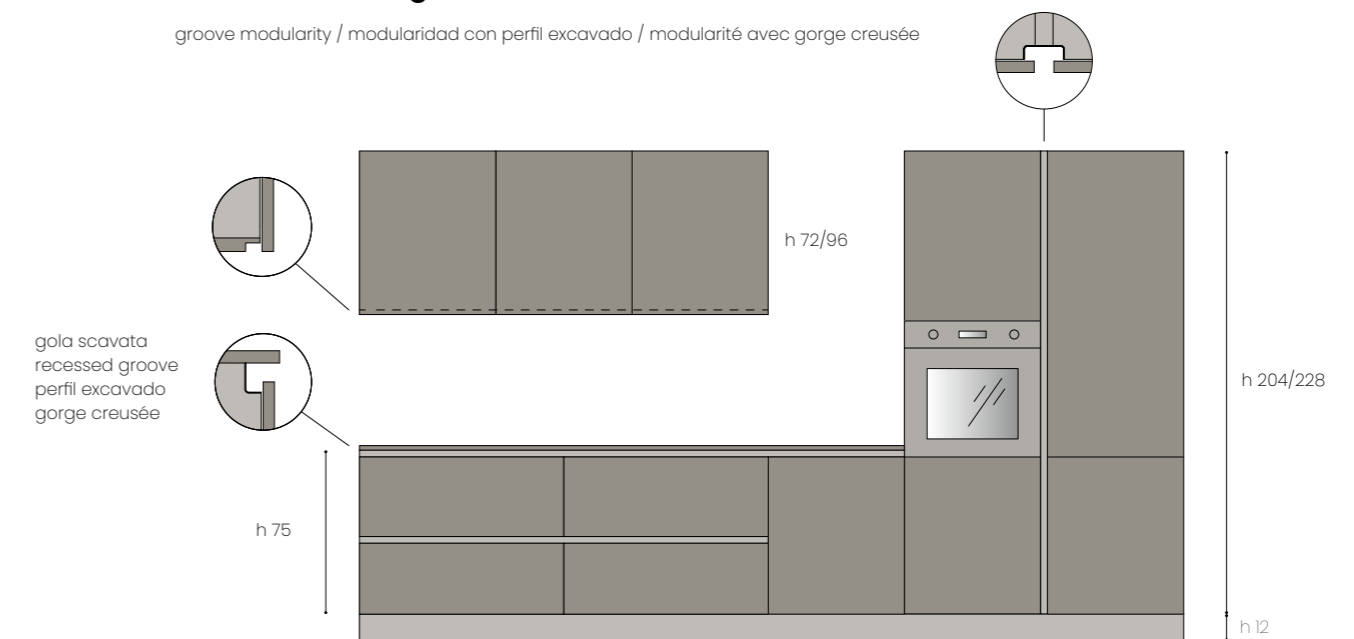

**Lumia 01**

art house

**12-21**



**Kaya 01**

art house

**22-31**



**Lumia 02**

art house

**32-41**



**Lumia 03**

art house

**42-51**



**Sveva 01**

art house

**52-61**



**Kaya 02**

art house

**62-71**



**Kaya 03**

art house

**72-81**



**Kaya 04**

art house

**82-91**



**Sveva 02**

art house

**92-101**



**Kaya 05**

art house

**102-111**



**Kaya 06**

art house

**112-121**



**Sveva 03**

art house

**122-131**



# Index

2	What is Art?
4	Green production
6	Certifications
8	Art collection data
12	Lumia 01
22	Kaya 01
32	Lumia 02
42	Lumia 03
52	Sveva 01
62	Kaya 02
72	Kaya 03
82	Kaya 04
92	Sveva 02
102	Kaya 05
112	Kaya 06
122	Sveva 03
132	Technical data
138	Door finishes
144	Worktop finishes



Lumia 01

Un rifugio compatto e funzionale ricco di luce e materia

# Lumia 01

Una cucina in cui il necessario è condensato in un unico spazio dove è possibile svolgere tutte le funzioni nella massima ergonomia. La composizione dona un senso di accoglienza grazie alla penisola con piano cottura ed al portale generato dai sopracolonna sospesi ed i pensili con decoro riga. Le finiture lucide dei frontali si mescolano ai differenti materiali in maniera armoniosa e donano lucentezza tutt'attorno.

A kitchen in which the necessary is condensed into a single space where it is possible to perform all functions in maximum ergonomics. The composition gives a sense of coziness thanks to the peninsula with hob and the portal generated by the suspended overcolumns and the wall units with stripe decoration. The glossy finishes of the fronts blend harmoniously with the different materials and give shine all around.

Una cocina en la que lo esencial se condensa en un único espacio en el que se pueden realizar todas las funciones con la máxima ergonomía. La composición transmite una sensación acogedora gracias a la península con placa de cocción y al portal generado por el sobremueble suspendido y los armarios altos con decoración a rayas. Los acabados de alto brillo de los frentes combinan armoniosamente con los distintos materiales y dan brillo a todo el conjunto.

Une cuisine dans laquelle l'essentiel est condensé en un seul espace où toutes les fonctions peuvent être exécutées avec un maximum d'ergonomie. La composition donne une impression de convivialité grâce à la presqu'île avec la table de cuisson et au portail généré par le meuble haut et les éléments muraux avec un décor à rayures. Les finitions brillantes des façades se marient harmonieusement avec les différents matériaux et donnent de l'éclat à l'ensemble.







Lumia 01



## Lumia 01

Pensile in laccato opaco finitura Milk White con decoro traccia sfalsata simmetrica, schienale in laminato pietra sp. 2 cm in finitura Pulipis light.

Wall unit in matte lacquered Milk white finish with Traccia ribbed decoration, stone laminate backplash 2 cm thickness in Pulipis light finish.

Mueble alto en acabado Milk white lacado mate con decoración de rayas traccia, panel trasero en laminado de piedra de 2 cm de grosor en acabado Pulipis light.

Meuble haut en finition Milk white laquée mate avec décor de rayures traccia, retour en stratifié pierre de 2 cm d'épaisseur en finition Pulipis light.





Basi e colonne in finitura laccato lucido Milk white, boiserie Unico con montanti alluminio nero opaco e mensola in Thermo strutturato finitura Argentina.

Base and tall units in Milk white glossy lacquer finish, Unico boiserie with matte black aluminum frames and shelf in Thermo structured Argentina finish.

Módulos bajos y altos en acabado lacado Blanco brillante, boiserie Unico con montantes de aluminio negro mate y estante en acabado Thermo Argentina texturado.

Meubles bas et hauts en finition laquée Blanc brillant, boiserie Unico avec montants en aluminium noir mat et étagère en finition Thermo structurée Argentina.

### Dettagli composizione

Composition details Detalles de composición Détails de la composition

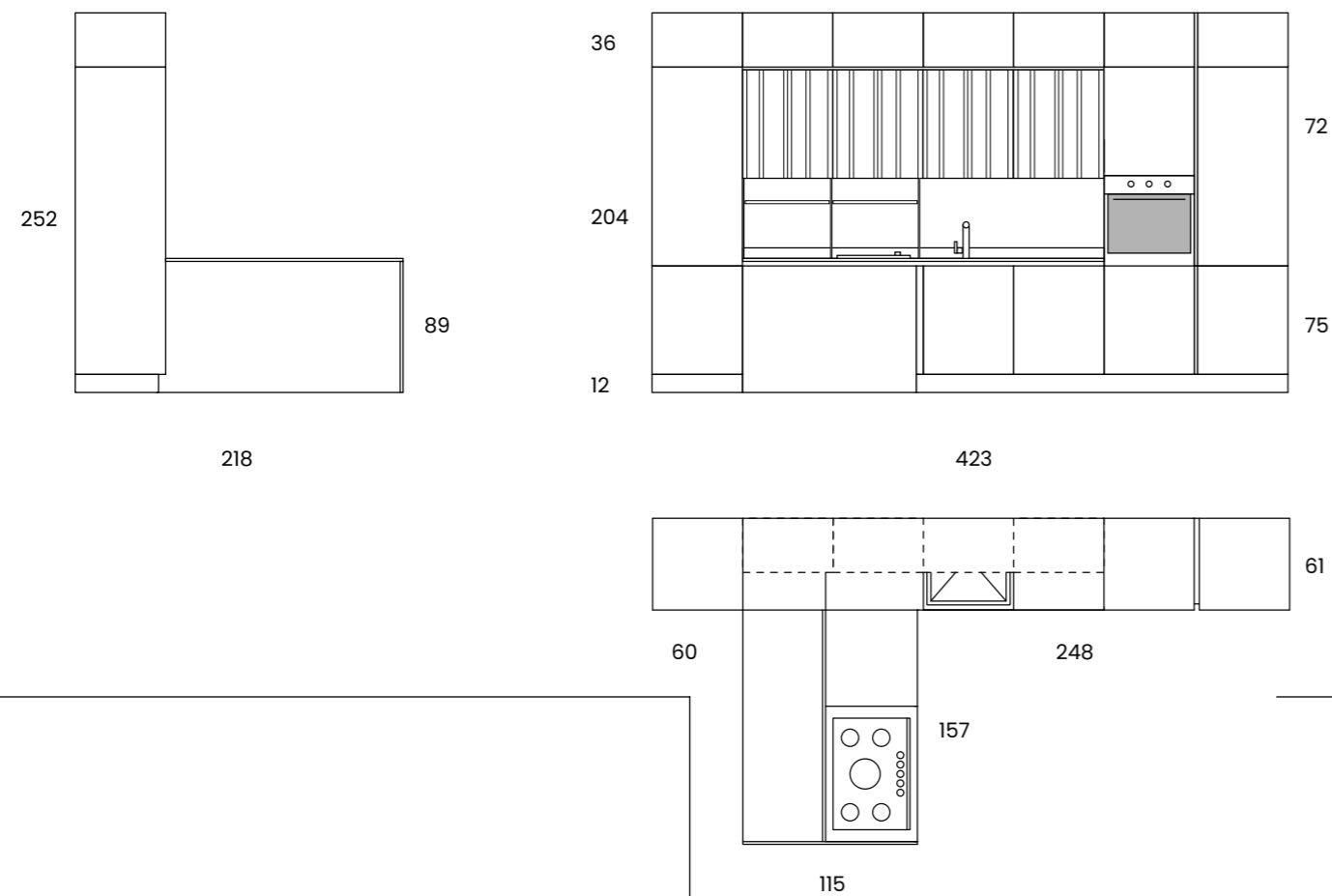

### Finiture

Ante colonne e sopra-colonne  
Laccato lucido - Milk white lucido

Ante basi  
Laccato lucido - Milk white lucido

Ante pensili  
Laccato opaco traccia - Milk white opaco

Worktop in laminato sp. 2 cm - Pulipis light  
Schienale e fianco penisola - Pulipis light

Gola scavata - Titanio  
Zoccolo h 12 PVC - Titanio

### Finishes

Tall unit doors and above tall units  
Glossy lacquered - Milk white lucido

Base cabinet doors  
Glossy lacquered - Milk white lucido

Wall unit doors  
Matt lacquered traccia effect - Milk white opaco

Worktop in Laminate sp. 2 cm - Pulipis light  
Backsplash and side panel - Pulipis light

Groove recessed - Titanio  
Plinth h 12 PVC - Titanio

### Acabados

Portes colonnes y sobrecolumna  
Lacado brillante - Milk white lucido

Puertas de bajos  
Lacado brillante - Milk white lucido

Puertas de altos  
Traccia lacada mate - Milk white opaco

Encimeras de laminado sp. 2 cm - Pulipis light  
Espalda y lado peninsula - Pulipis light

Perfil tirador excavado - Titanio  
Rodapiés h 12 PVC - Titanio

### Finitions

Portes colonnes et sur-colonne  
Laqué brillant - Milk white lucido

Portes meubles bas  
Laqué brillant - Milk white lucido

Portes meubles hauts  
Laqué mat traccia - Milk white opaco

Plateaux en laminé 2 cm - Pulipis light  
Retour et côté péninsule - Pulipis light

Gorge creusée - Titanio  
Plinthes h 12 PVC - Titanio

# Lumia 01

art house

Milk white lucido

Milk white opaco traccia

Pulipis light



Kaya 01

Colore e materia si fondono in ambiente eclettico e vivace

## Kaia 01

Una composizione pensata per fondere in un unico spazio cucina e living. Di fatti a sinistra si sviluppa una cucina completa mentre a destra le colonne proseguono con un'area credenza attrezzata con basi basse pensate per ospitare un comodo tavolo da pranzo. Il piano in legno con gamba in metallo racchiude lo spazio e consente di vivere momenti di convivialità all'interno dello spazio cucina.

A composition designed to merge kitchen and living room into a single space. In fact, a full kitchen is developed on the left, while on the right the columns continue with a glass area equipped with low bases designed to accommodate a comfortable dining table. The wooden top with metal leg encloses the space and allows moments of conviviality within the kitchen space.

Una composición diseñada para fusionar la cocina y el salón en un único espacio. A la izquierda hay una cocina completa, mientras que a la derecha las columnas continúan con una zona de aparador equipada con muebles bajos diseñados para albergar una cómoda mesa de comedor. La encimera de madera con pata metálica cierra el espacio y permite momentos de convivencia dentro del espacio de la cocina.

Une composition conçue pour fusionner la cuisine et le salon en un seul espace. À gauche, on trouve une cuisine complète tandis qu'à droite, les colonnes se poursuivent avec une zone de buffet équipée d'éléments bas conçus pour accueillir une table de salle à manger confortable. Le plateau en bois et les pieds en métal délimitent l'espace et permettent des moments de convivialité dans la cuisine.



Kaya 01



Kaya 01



## Kaya 01

Vano a giorno con ante scorrevoli in vetro fumè e telaio in alluminio nero opaco, ante laccato opaco Milk white con decoro traccia.

Open wall unit with sliding doors in fumè glass and frame in matt black aluminum, Milk white matte lacquered doors with traccia decoration.

Mueble alto abierto con puertas correderas en cristal ahumado y estructura en aluminio negro mate, puertas lacadas en Milk white mate con decoración de rayas traccia.

Unité murale ouverte avec portes coulissantes en verre fumé et cadre en aluminium noir mat, portes laquées Milk white mat avec décor de rayures traccia.





Kaya 01

Basi basse in nobilitato opaco finitura Ink, piano snack in laminato Rovere sole e gambone telescopico in metallo nero opaco.

Low base cabinets in Ink finish matt melamine, snack top in Rovere sole laminate and telescoping leg in matt black metal.

Base baja en melamina acabado Ink mate, mesa en laminado Rovere sole y pata telescópica en metal negro mate.

Base basse en mélamine finition Ink mat, plateau de table en stratifié Rovere sole et pied télescopique en métal noir mat.

## Dettagli composizione

Composition details Detalles de composición Détails de la composition

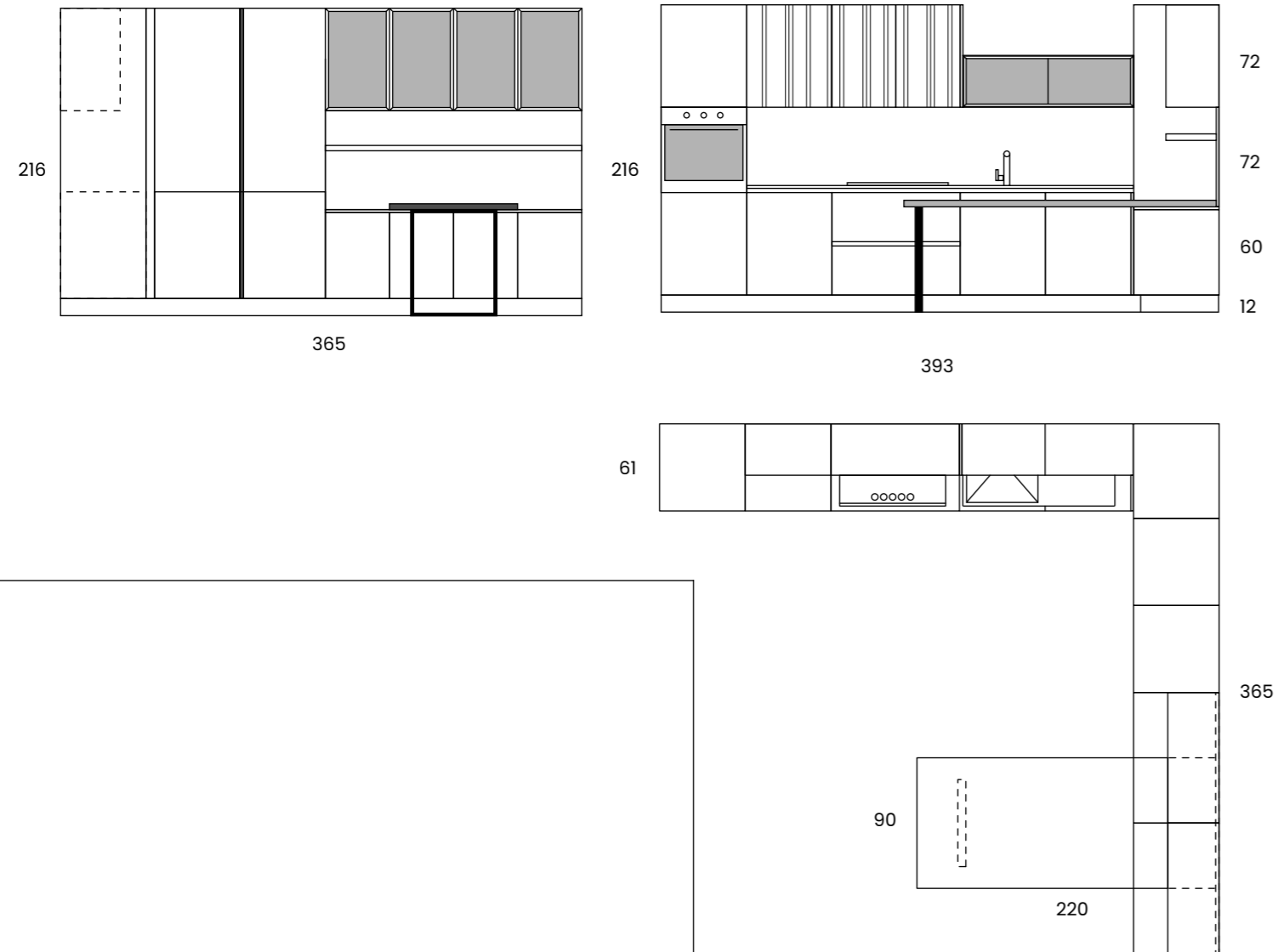

## Finiture

Ante colonne  
Nobilitato opaco Matt chic - Ink

Ante basi  
Nobilitato opaco Matt chic - Ink

Ante pensili  
Laccato opaco traccia - Milk white opaco  
Vetro fumé e telaio alluminio nero

Worktop in laminato sp. 2 cm - Rovere sole  
Schienale - Rovere sole  
Piano tavolo in laminato sp. 4 cm - Rovere sole

Gola scavata - Nero opaco  
Zoccolo h 12 PVC verniciato - Nero opaco

## Finishes

Tall unit doors  
Matt chic melamine - Ink

Base cabinet doors  
Matt chic melamine - Ink

Wall unit doors  
Matt lacquered traccia - Milk white opaco  
Fumé glass and black aluminum frame

Worktop in Laminato sp. 2 cm - Rovere sole  
Backsplash - Rovere sole  
Table top in laminate 4 cm - Rovere sole

Groove recessed - Nero opaco  
Plinth h 12 painted PVC - Nero opaco

## Acabados

Portes colonnes  
Melamina mate Matt chic - Ink

Puertas de bajos  
Melamina mate Matt chic - Ink

Puertas de altos  
Traccia lacada mate - Milk white opaco  
Vidrio fumé y marco de aluminio negro

Encimeras de laminado sp. 2 cm - Rovere sole  
Espalda - Rovere sole  
Mesa de laminado 4 cm - Rovere sole

Perfil tirador excavado - Nero opaco  
Rodapiés h 12 PVC barnizado - Nero opaco

## Finitions

Portes colonnes  
Bois amélioré mat Matt chic - Ink

Portes meubles bas  
Bois amélioré mat Matt chic - Ink

Portes meubles hauts  
Laqué mat traccia - Milk white opaco  
Verre fumé et cadre en aluminium noir

Plateaux en laminé 2 cm - Rovere sole  
Retour - Rovere sole  
Dessus de la table en laminé 4 cm - Rovere sole

Gorge creusée - Nero opaco  
Plinthes h 12 PVC peint - Nero opaco

# Kaya 01

art house

Ink

Rovere sole

Milk white opaco traccia

Black Matt





Lumia 02

Differenti volumi danno luogo ad un arcipelago di emozioni

## Lumia 02

Un ambiente da vivere a fondo e nella massima comodità, ogni funzione determina un volume a se stante. La composizione di fatti è suddivisa in tre grandi volumi: un'isola dedicata alla cottura, le colonne con forno e frigo, le basi a parete con funzione lavaggio. Ad unire il tutto interviene il piano snack posizionato a sbalzo tra le basi, utile per momenti di convivialità e condivisione.

An environment to live thoroughly and in maximum comfort, each function determines a volume in its own right. The composition is divided into three large volumes: an island dedicated to cooking, columns with oven and refrigerator, and wall bases with washing function. To connect everything intervenes the snack top positioned cantilevered between the bases, useful for moments of conviviality and sharing.

Una estancia para ser vivida a fondo y con el máximo confort, cada función determina un volumen en sí misma. La composición fatti se divide en tres grandes volúmenes: una isla dedicada a la cocción, columnas con horno y frigorífico, y muebles bajos suspendidos con función de lavado. Todo está unido por la encimera snack colocada en voladizo entre los muebles bajos, útil para los momentos de convivencia y para compartir.

Une pièce à vivre pleinement et avec un maximum de confort, dont chaque fonction détermine un volume à part entière. La composition fatti est divisée en trois grands volumes : un îlot dédié à la cuisson, des colonnes avec four et réfrigérateur, et des éléments bas muraux avec fonction de lavage. Le tout est uni par le plan snack positionné en porte-à-faux entre les éléments bas, utile pour les moments de convivialité et de partage. en un espace repas.





Lumia 02



## Lumia 02

Pensili in nobilitato opaco finitura Siena, boiserie in termo strutturato finitura Noce Svezia e mensole in nobilitato opaco finitura Cotton.

Wall cabinet in matt melamine Siena finish, boiserie in thermo structured Noce Svezia finish and shelves in matt melamine Cotton finish.

Módulos altos en melamina mate Siena, boiserie en acabado termoestructurado Noce Siena y estantes en melamina mate Cotton.

Meubles hauts en mélaminé mat Siena, boiserie en thermo structuré Noce Siena et étagères en mélaminé mat Cotton.



Basi laccato lucido finitura Cotton, piano snack in laminato finitura Slate grey. Worktop in laminato finitura Yule White.

Base units glossy lacquered Cotton finish, snack top in laminate Slate grey finish. Worktop in laminate Yule White finish.

Módulos bajos en lacado brillante acabado Cotton, encimera de snack en laminado acabado Slate grey. Encimera en laminado acabado Yule White.

Meubles bas laqués brillants finition Cotton, plan snack en stratifié finition Slate grey. Plan de travail en stratifié finition Yule White.

## Dettagli composizione

Composition details Detalles de composición Détails de la composition

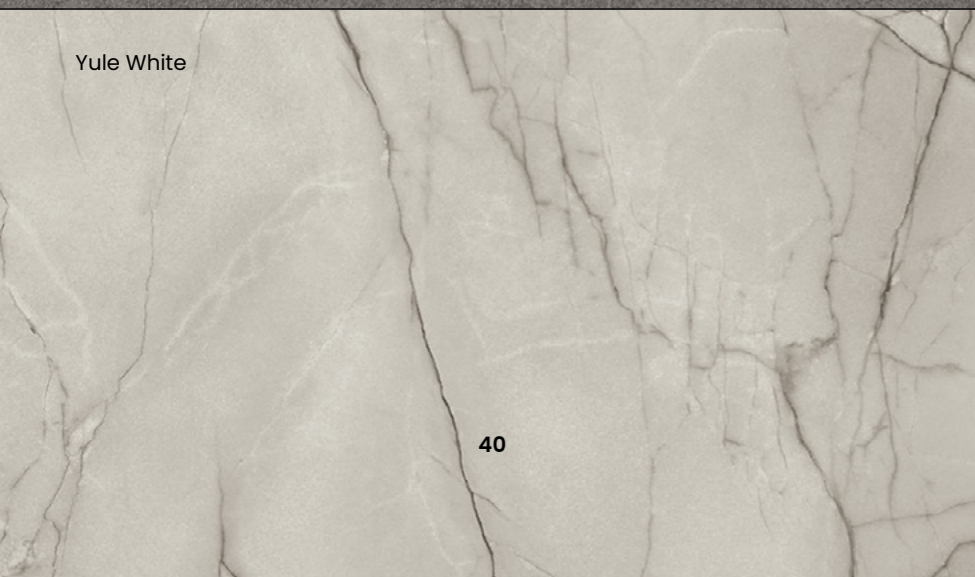
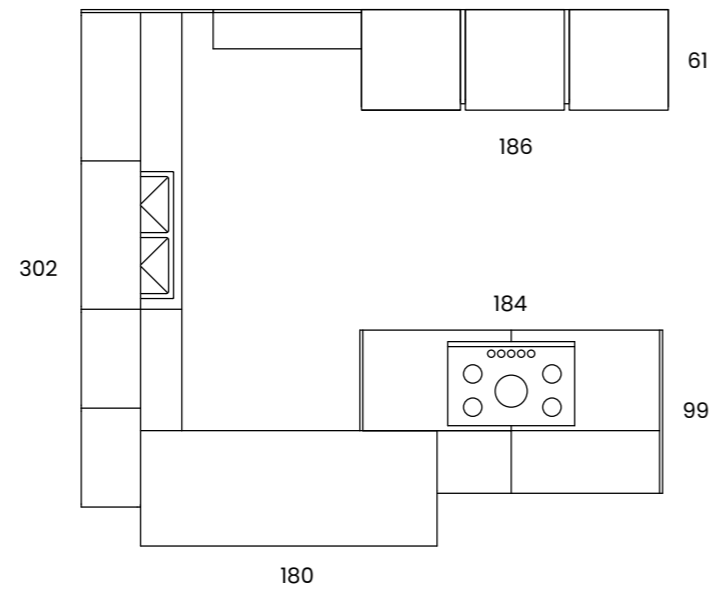
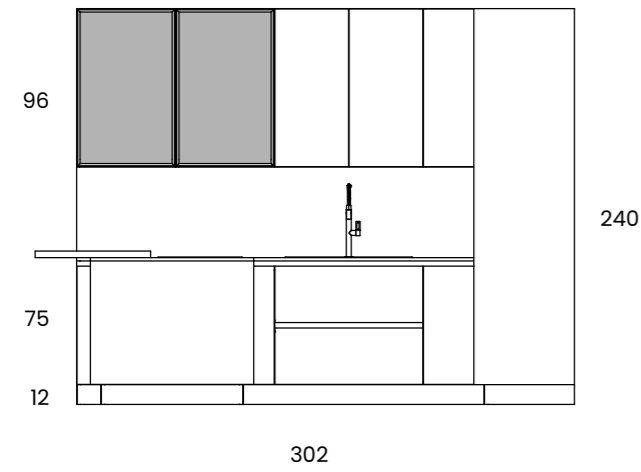

## Finiture

Ante colonne e ante basi  
Laccato lucido - Cotton lucido

Ante basi  
Termostrutturato legno materico - Noce Svezia

Ante pensili  
Nobilitato opaco Matt chic - Siena opaco  
Vetro fumè e telaio alluminio nero

Worktop in laminato sp. 2 cm - Yule white  
Schienale - Yule white  
Piano snack in laminato sp. 4 cm - Slate grey

Gola scavata - Titanio  
Zoccolo h 12 PVC - Titanio

## Finishes

Tall unit doors and base cabinet doors  
Glossy lacquered - Cotton lucido

Base cabinet doors  
Wood effect thermostructured - Noce Svezia

Wall unit doors  
Matt chic melamine - Siena opaco  
Fumè glass and black aluminum frame

Worktop in Laminate sp. 2 cm - Yule white  
Backsplash - Yule white  
Snack top in laminate 4 cm - Slate grey

Groove recessed - Titanio  
Plinth h 12 PVC - Titanio

## Acabados

Portes colonnes y puertas de bajos  
Lacado brillante - Cotton lucido

Puertas de bajos  
Termoestructurado matérico madera - Noce Svezia

Puertas de altos  
Melamina mate Matt chic - Siena opaco  
Vidrio fumè y marco de aluminio negro

Encimeras de laminado sp. 2 cm - Yule white  
Espalda - Yule white  
Mesa de laminado 4 cm - Slate grey

Perfil tirador excavado - Titanio  
Rodapiés h 12 PVC - Titanio

## Finitions

Portes colonnes et portes meubles bas  
Laqué brillant - Cotton lucido

Portes meubles bas  
Thermostructuré bois texturé - Noce Svezia

Portes meubles hauts  
Melamina mate Matt chic - Siena opaco  
Verre fumé et cadre en aluminium noir

Plateaux en laminé 2 cm - Yule white  
Retour - Yule white  
Dessus de la table en laminé 4 cm - Slate grey

Gorge creusée - Titanio  
Plinthes h 12 PVC - Titanio

# Lumia 02

art house

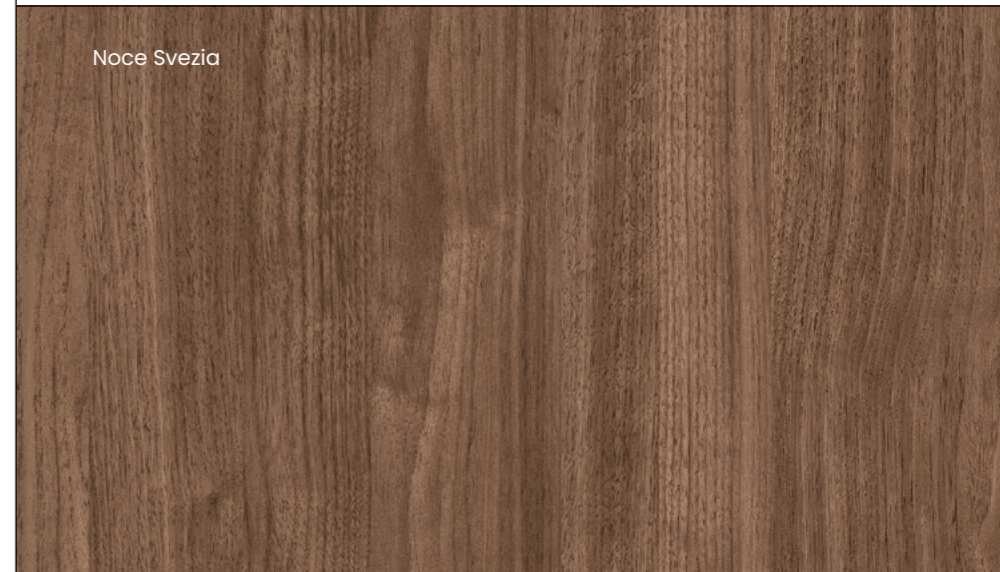



Lumia 03

Superfici riflettenti si fondono in uno spazio dall'animo dark

## Lumia 03

La massima funzionalità per una cucina attenta al modo di vivere contemporaneo dove gli spazi sono mutevoli e fluidi. Un'isola predomina la scena ed è connotata da un vano a giorno centrale per accogliere le aperture della zona living, conclude con un piano tavolo comodo per vivere ogni momento nella piena libertà. A parete le colonne ed i pensili alti racchiudono una comoda area lavaggio.

Maximum functionality for a kitchen focused on the contemporary way of living where spaces are changeable and fluid. An island dominates the scene and is connoted by a central open compartment to welcome the openings of the living area, concludes with a comfortable table top to live every moment in full freedom. On the wall, tall columns and wall units enclose a comfortable washing area.

Máxima funcionalidad para una cocina atenta a la vida contemporánea, donde los espacios son cambiantes y fluidos. Una isla domina la escena y se caracteriza por un compartimento central abierto para acoger las aberturas de la zona de estar, que concluye con un cómodo tablero para disfrutar de cada momento con total libertad. En la pared, altas columnas y muebles altos encierran una cómoda zona de lavado.

Une fonctionnalité maximale pour une cuisine attentive à la vie contemporaine où les espaces sont changeants et fluides. Un îlot domine la scène et se caractérise par un compartiment central ouvert pour accueillir les ouvertures de la zone de vie, se terminant par un confortable plateau de table pour profiter de chaque instant en toute liberté. Sur le mur, de hautes colonnes et des éléments muraux délimitent un espace de lavage pratique, en un espace repas.





Lumia 03



## Lumia 03

Piano tavolo in laminato finitura Rovere sole con gamba Loft in metallo finitura nero opaco. Sedia Eva con struttura e seduta finitura nero opaco.

Table top in laminate Rovere sole finish equipped with Loft leg in metal matt black finish. Eva chair with structure and seat matt black finish.

Mesa en laminado acabado Rovere sole con pata Loft de metal acabado negro mate. Silla Eva con estructura y asiento en negro mate.

Plateau de table en stratifié finition Rovere sole avec pied Loft en métal finition noir mat. Chaise Eva avec structure et assise en noir mat.







Zona living, top e mensola in nobilitato opaco finitura Ink, pensile in nobilitato opaco finitura Cotton.

Living area, top and shelf in matt melamine Ink finish, wall unit in matt melamine Cotton finish.

Salle de séjour, sobre y baldas en melamínico acabado Ink mate, mueble alto de melamina mate acabado Cotton.

Sala de estar, plateau et étagères en mélaminé mat finition Ink, meuble haut en mélaminé finition Cotton mat.

### Dettagli composizione

Composition details Detalles de composición Détails de la composition

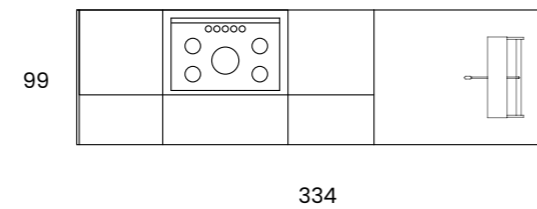
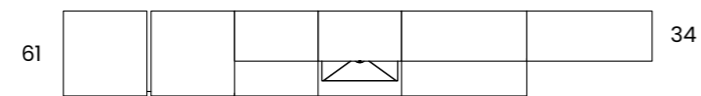
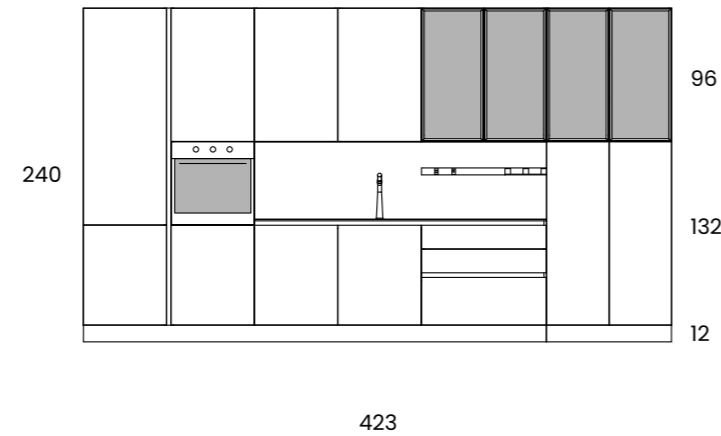
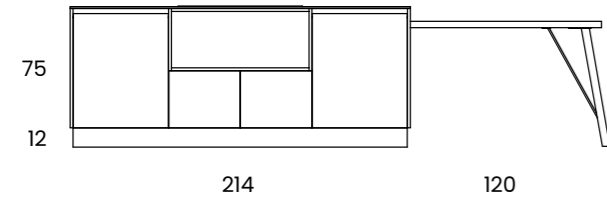

### Finiture

Ante colonne  
Laccato lucido - Cobalt grey lucido

Ante basi  
Laccato lucido - Cobalt grey lucido

Ante pensili  
Laccato lucido - Cobalt grey lucido  
Vetro fumè e telaio alluminio nero

Worktop in gres Neolith sp. 12 cm - Everest sunrise silk  
Schienale - Everest sunrise silk  
Piano tavolo in laminato sp. 4 cm - Rovere sole

Gola scavata - Nero opaco  
Zoccolo h 12 PVC verniciato - Nero opaco

### Finishes

Tall unit doors  
Glossy lacquered - Cobalt grey lucido

Base cabinet doors  
Glossy lacquered - Cobalt grey lucido

Wall unit doors  
Glossy lacquered - Cobalt grey lucido  
Fumè glass and black aluminum frame

Worktop in gres Neolith sp. 12 cm - Everest sunrise silk  
Backsplash - Everest sunrise silk  
Table top in laminate 4 cm - Rovere sole

Groove recessed - Nero opaco  
Plinth h 12 painted PVC - Nero opaco

### Acabados

Portes colonnes  
Lacado brillante - Cobalt grey lucido

Puertas de bajos  
Lacado brillante - Cobalt grey lucido

Puertas de altos  
Lacado brillante - Cobalt grey lucido  
Vidrio fumè y marco de aluminio negro

Encimeras de gres Neolith sp. 12 cm - Everest sunrise silk  
Espalda - Everest sunrise silk  
Mesa de laminado 4 cm - Rovere sole

Groove recessed - Nero opaco  
Plinth h 12 painted PVC - Nero opaco

### Finitions

Portes colonnes  
Laqué brillant - Cobalt grey lucido

Portes meubles bas  
Laqué brillant - Cobalt grey lucido

Portes meubles hauts  
Laqué brillant - Cobalt grey lucido  
Verre fumé et cadre en aluminium noir

Plateaux en gres Neolith 12 cm - Everest sunrise silk  
Retour - Everest sunrise silk  
Dessus de la table en laminé 4 cm - Rovere sole

Gorge creusée - Nero opaco  
Plinthes h 12 PVC peint - Nero opaco

# Lumia 03

art house

Rovere Sole

Cobalt grey lucido

Ink

Everest Sunrise Silk



Il calore dello stile contemporaneo si fonde con il rigore moderno

# Sveva 01

Come un caldo abbraccio la composizione ad angolo completa l'ambiente donando armonia e carattere. Le ante telaio del modello Sveva si arricchiscono di un nuovo colore e vengono accompagnate da una gola in tinta, con l'obiettivo di dare un senso di continuità. Un grande volume in vetro ed alluminio sovrasta le basi a parete aprendo così un varco verso il rigore del design moderno.

Like a warm embrace, the corner composition completes the room while giving harmony and character. The frame doors of the Sveva model are enriched with a new color and are matched with a tone-on-tone groove, aiming to give a sense of continuity. A large volume in glass and aluminum dominates the wall bases, thus opening a gateway to the rigor of modern design.

Como un cálido abrazo, la composición esquinera completa la estancia aportando armonía y carácter. Las puertas con marco del modelo Sveva se enriquecen con un nuevo color y se acompañan de una ranura a juego para dar sensación de continuidad. Un gran volumen de cristal y aluminio remata los zócalos murales, abriendo paso al rigor del diseño moderno.

Comme une étreinte chaleureuse, la composition d'angle complète la pièce en lui donnant de l'harmonie et du caractère. Les portes à cadre du modèle Sveva s'enrichissent d'une nouvelle couleur et sont accompagnées d'une rainure assortie pour donner une impression de continuité. Un grand volume en verre et aluminium surmonte les bases murales, ouvrant un passage à la rigueur du design moderne.





Sveva 01



## Sveva 01

Ante a vetro Ella con telaio in alluminio nero opaco e vetro fumé. Piano tavolo in cemento materico finitura Sand e gamba Loft finitura metallo nero opaco.

Ella glass doors with matt black aluminium frame and fumé glass. Table top in textured concrete Sand finish and Loft leg in matt black metal finish.

Puertas de cristal Ella con marco de aluminio negro mate y cristal ahumado. Tablero en cemento Sand y pata Loft en metal negro mate.

Portes en verre Ella avec cadre en aluminium noir mat et verre fumé. Plateau de table en finition Sand materic cement et pied Loft en finition métal noir mat.





Basi modello Sveva in Alkorcell finitura White matt. Worktop in gres Neolith sp. 12 cm finitura Calacatta Luxe lucido GL.

Base units Sveva model in Alkorcell White matt finish. Neolith gres worktop th. 12 cm Calacatta Luxe lucido GL finish.

Muebles bajos modelo Sveva en Alkorcell acabado White matt. Encimera en gres Neolith de 12 cm de espesor con acabado Calacatta Luxe lucido GL.

Meubles bas modèle Sveva en Alkorcell finition White matt. Plan de travail en grès Neolith de 12 cm d'épaisseur avec finition Calacatta Luxe lucido GL.

### Dettagli composizione

Composition details Detalles de composición Détails de la composition

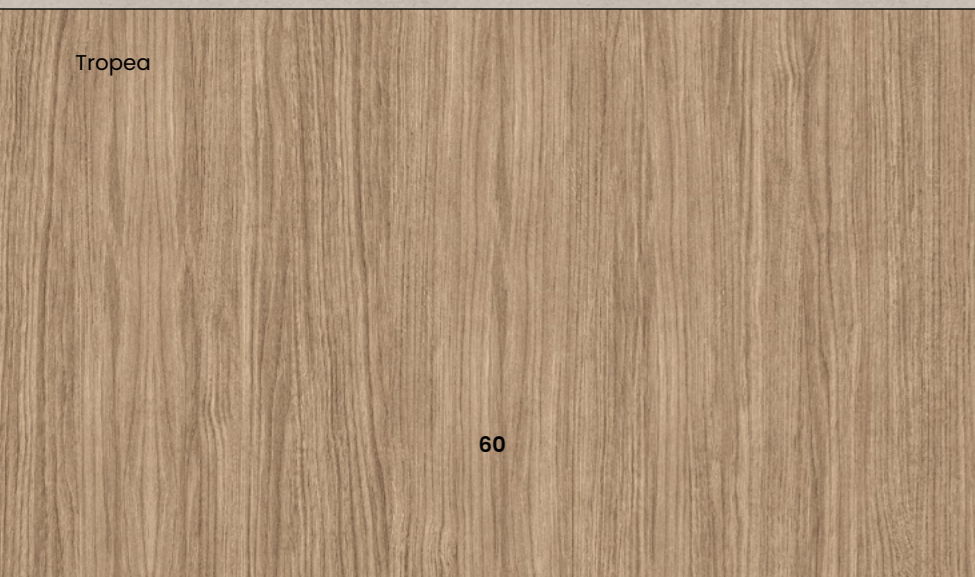
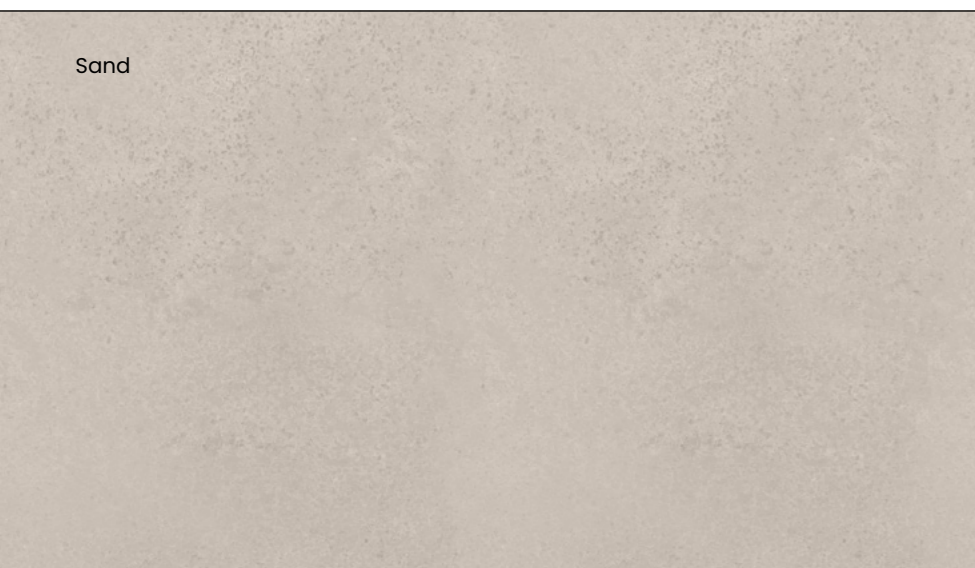
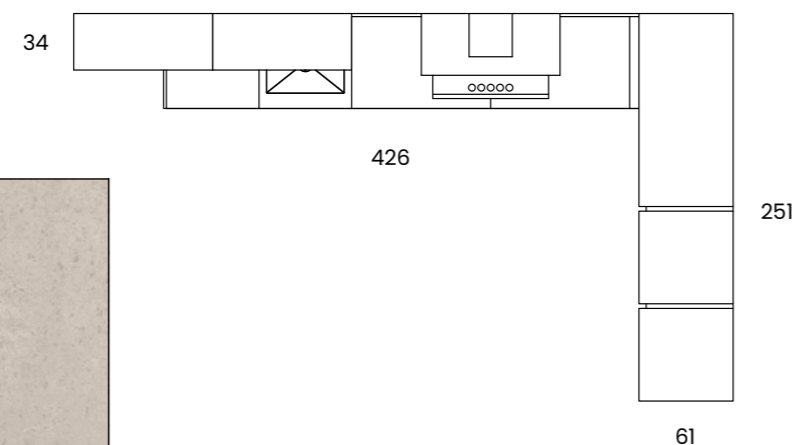
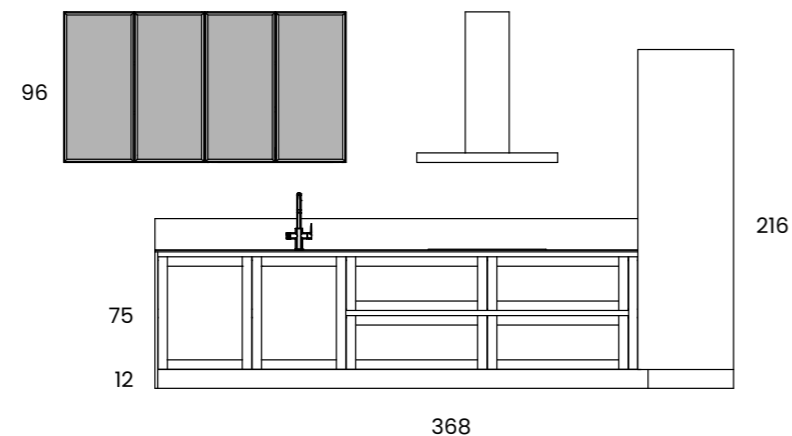
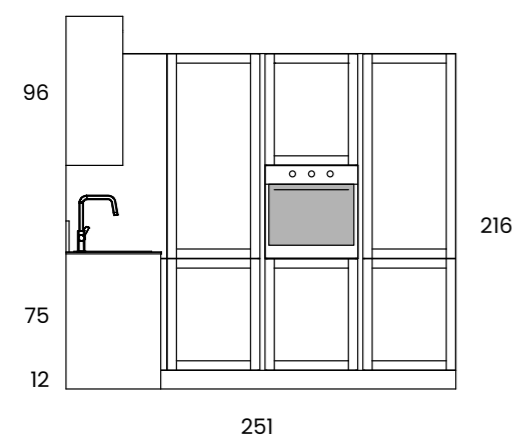

60

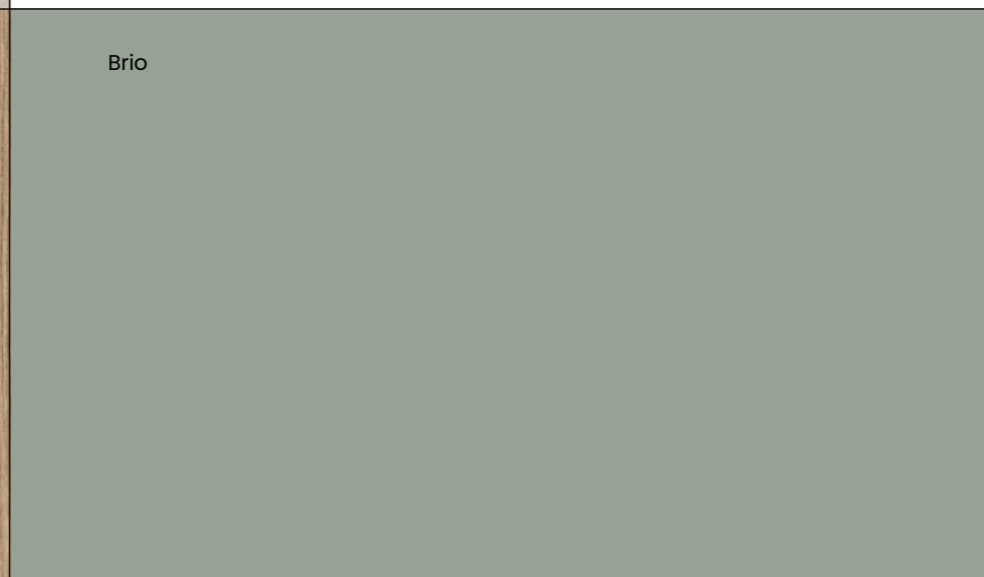

### Finiture

Ante colonne  
Nobilitato opaco Matt chic - Vanilla Ice

Ante basi  
Sveva alkorcell - White matt

Ante pensili  
Vetro fumè e telaio alluminio nero

Worktop in gres Neolith sp. 12 cm - Calacatta Luxe lucido GL  
Schienale - Calacatta Luxe lucido GL  
Piano tavolo in laminato sp. 4 cm - Sand

Gola scavata - Titanio  
Zoccolo h 12 PVC - Titanio

### Finishes

Tall unit doors  
Matt chic melamine - Vanilla Ice

Base cabinet doors  
Sveva alkorcell - White matt

Wall unit doors  
Fumè glass and black aluminum frame

Worktop in gres Neolith sp. 12 cm - Calacatta Luxe lucido GL  
Backsplash - Calacatta Luxe lucido GL  
Table top in laminate 4 cm - Sand

Groove recessed - Titanio  
Plinth h 12 PVC - Titanio

### Acabados

Portes colonnes  
Melamina mate Matt chic - Vanilla Ice

Puertas de bajos  
Sveva alkorcell - White matt

Puertas de altos  
Vidrio fumè y marco de aluminio negro

Encimeras de gres Neolith sp. 12 cm - Calacatta Luxe lucido GL  
Espalda - Calacatta Luxe lucido GL  
Mesa de laminado 4 cm - Sand

Groove recessed - Titanio  
Plinth h 12 PVC - Titanio

### Finitions

Portes colonnes  
Bois amélioré mat Matt chic - Vanilla Ice

Portes meubles bas  
Sveva alkorcell - White matt

Portes meubles hauts  
Verre fumé et cadre en aluminium noir

Plateaux en gres Neolith 12 cm - Calacatta Luxe lucido GL  
Retour - Calacatta Luxe lucido GL  
Dessus de la table en laminé 4 cm - Sand

Gorge creusée - Titanio  
Plinthes h 12 PVC - Titanio

# Sveva 01

art house

Vanilla Ice

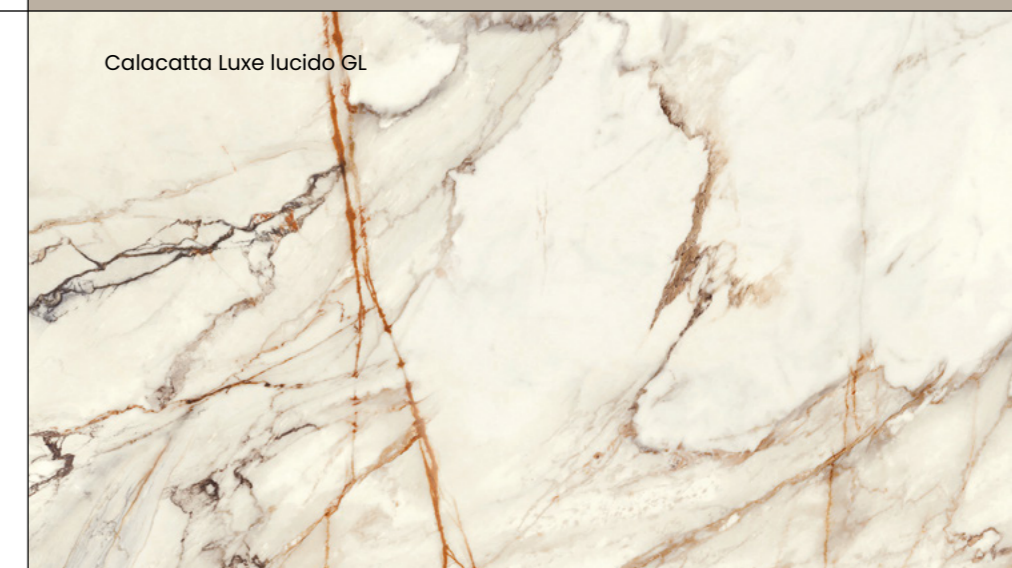

White matt

61



Kaya 02

Rigorosi volumi fusi in uno spazio dall'animo conviviale

## Kaya 02

Forme semplici e chiare per ambienti domestici in cui tutto si fonde per far vivere momenti indimenticabili in famiglia e con gli amici. L'ambiente è connotato da una parete centrale attorno alla quale si sviluppano armadiature e zona giorno. I pensili si plasmano per consentire alla cucina di trasformarsi da area deputata alla preparazione dei cibi ad area pranzo.

These simple, clear lines inspire a home environment in which everything combines to create unforgettable moments with family and friends. The environment is characterized by a central wall around which wardrobes and living areas develop. The wall units are shaped to allow the kitchen to transform from an area dedicated to food preparation into a dining area.

Estas líneas simples y claras inspiran un ambiente hogareño en el que todo se combina para crear momentos inolvidables con la familia y los amigos. El ambiente se caracteriza por un muro central alrededor del cual se desarrollan los armarios y las zonas de estar. Los muebles altos tienen forma para permitir que la cocina se transforme de un área dedicada a la preparación de alimentos en un comedor.

Ces lignes simples et claires inspirent un environnement domestique dans lequel tout se combine pour créer des moments inoubliables avec la famille et les amis. L'environnement est caractérisé par un mur central autour duquel se développent des armoires et des espaces de vie. Les éléments hauts sont façonnés pour permettre à la cuisine de se transformer d'un espace dédié à la préparation des aliments en un espace repas.







Kaya 02



## Kaya 02

Pensile a giorno con ante scorrevoli in vetro fumè e telaio in alluminio nero opaco, modulo a giorno Unico in alluminio nero opaco e mensole in Noce Svezia.

Open wall unit with sliding doors in fumè glass and frame in matt black aluminum, Unico open module in matt black aluminum and shelves in Noce Svezia.

Mueble alto abierto con puertas correderas en cristal ahumado y estructura en aluminio negro mate, módulo abierto Unico en aluminio negro mate y baldas en Noce Svezia.

Unité murale ouverte avec portes coulissantes en verre fumé et cadre en aluminium noir mat, module ouvert Unico en aluminium noir mat et étagères en Noce Svezia.





Basi basse e piano in nobilitato opaco finitura Siena, modulo a giorno Jolly e mensole in finitura Vulcan.

Lower bases and top in matt melamine Siena finish, Jolly open module and shelves in Vulcan finish.

Bases inferiores y sobre en melamínico acabado Siena mate, módulo abierto y baldas en acabado Vulcan.

Bases inférieures et plateau en mélaminé mat finition Siena, module ouvert et étagères en finition Vulcan.

## Dettagli composizione

Composition details Detalles de composición Détails de la composition



### Finiture

Ante colonne  
Termostrutturato legno materico - Noce Svezia

Ante basi  
Cemento materico - Pola

Ante pensili  
Cemento materico - Alu  
Vetro fumè e telaio alluminio nero

Worktop in laminato sp. 2 cm - Pola  
Schienale - Alu  
Piano tavolo in laminato sp. 4 cm - Slate grey

Gola scavata - Nero opaco  
Zoccolo h 12 PVC verniciato - Nero opaco

### Finishes

Tall unit doors  
Wood effect thermostructured - Noce Svezia

Base cabinet doors  
Cemento materico - Pola

Wall unit doors  
Cemento effect - Alu  
Fumè glass and black aluminum frame

Worktop in Laminate sp. 2 cm - Pola  
Backsplash - Alu  
Table top in laminate 4 cm - Slate grey

Groove recessed - Nero opaco  
Plinth h 12 painted PVC - Nero opaco

### Acabados

Portes colonnes  
Termoestructurado maderico - Noce Svezia

Puertas de bajos  
Maderico cemento - Pola

Puertas de altos  
Maderico cemento - Alu  
Vidrio fumè y marco de aluminio negro

Encimeras de laminado sp. 2 cm - Pola  
Espalda - Alu  
Mesa de laminado 4 cm - Slate grey

Perfil tirador excavado - Nero opaco  
Rodapiés h 12 PVC barnizado - Nero opaco

### Finitions

Portes colonnes  
Thermostructuré bois texturé - Noce Svezia

Portes meubles bas  
Kaya 1 Cimento materico - Pola

Portes meubles hauts  
Cemento effect - Alu  
Verre fumé et cadre en aluminium noir

Plateaux en laminé 2 cm - Pola  
Retour - Alu  
Dessus de la table en laminé 4 cm - Slate grey

Gorge creusée - Nero opaco  
Plinthes h 12 PVC peint - Nero opaco

# Kaya 02

art house

Noce Svezia

Pola

Slate grey

Alu

L'incontro perfetto tra volumi neutri e superfici materiche

# Kaya 03

Un'equilibrato gioco di volumi riesce a creare interessanti ed inedite atmosfere, i pensili si compenetrano con la mensola scura, come il piano della penisola in legno che sovrasta quella delle basi a parete. Lo spazio è governato da una penisola dai toni scuri che termina con un elemento a giorno e dalle colonne svuotate da un lato per consentire un ulteriore piano di appoggio.

A balanced play of volumes manages to create interesting and original atmospheres, the wall units interpenetrate with the dark shelf, like the top of the wooden peninsula that dominates the wall bases. The space is governed by a peninsula in dark tones that ends with an open element and by columns emptied on one side to allow for an additional support surface.

Un equilibrado juego de volúmenes consigue crear atmósferas interesantes y originales, los muebles altos se interpenetran con la estantería oscura, como el remate de la península de madera que domina la de las bases de pared. El espacio está regido por una península en tonos oscuros que remata en un elemento abierto y por columnas vaciadas en un lado para permitir una superficie de apoyo adicional.

Un jeu équilibré de volumes parvient à créer des atmosphères intéressantes et originales, les unités murales s'interpénètrent avec l'étagère sombre, comme le haut de la péninsule en bois qui domine celle des bases murales. L'espace est régi par une péninsule aux tons sombres qui se termine par un élément ouvert et par des colonnes vidées d'un côté pour permettre une surface d'appui supplémentaire.







## Kaya 03

Maniglia Square in alluminio nero opaco e piano di lavoro in Laminato finitura Petra. Basi in nobilitato Matt chic finitura Smoke grey.

Square handle in matt black aluminum and worktop in Laminate Petra finish. Bases in Matt chic melamine Smoke grey finish.

Tirador cuadrado en aluminio negro mate y encimera en Laminado acabado Petra. Bases en melaminico Matt chic acabado Smoke grey.

Poignée carrée en aluminium noir mat et plan de travail en stratifié avec finition Petra. Bases en mélaminé Matt chic finition Smoke grey.





Tavolo Plutone con struttura nera e piano in melaminico Antracite. Sedie Tata young con struttura e seduta nero opaco.

Plutone table with black structure and Antracite melamine top. Tata young chairs with matt black structure and seat.

Mesa Plutone con estructura negra y tapa de melamina Antracite. Silla Tata young con estructura y asiento negra mate.

Table Plutone avec structure noire et plateau en mélaminé Antracite. Chaises Tata young avec structure et assise noire mat.



## Dettagli composizione

Composition details Detalles de composición Détails de la composition

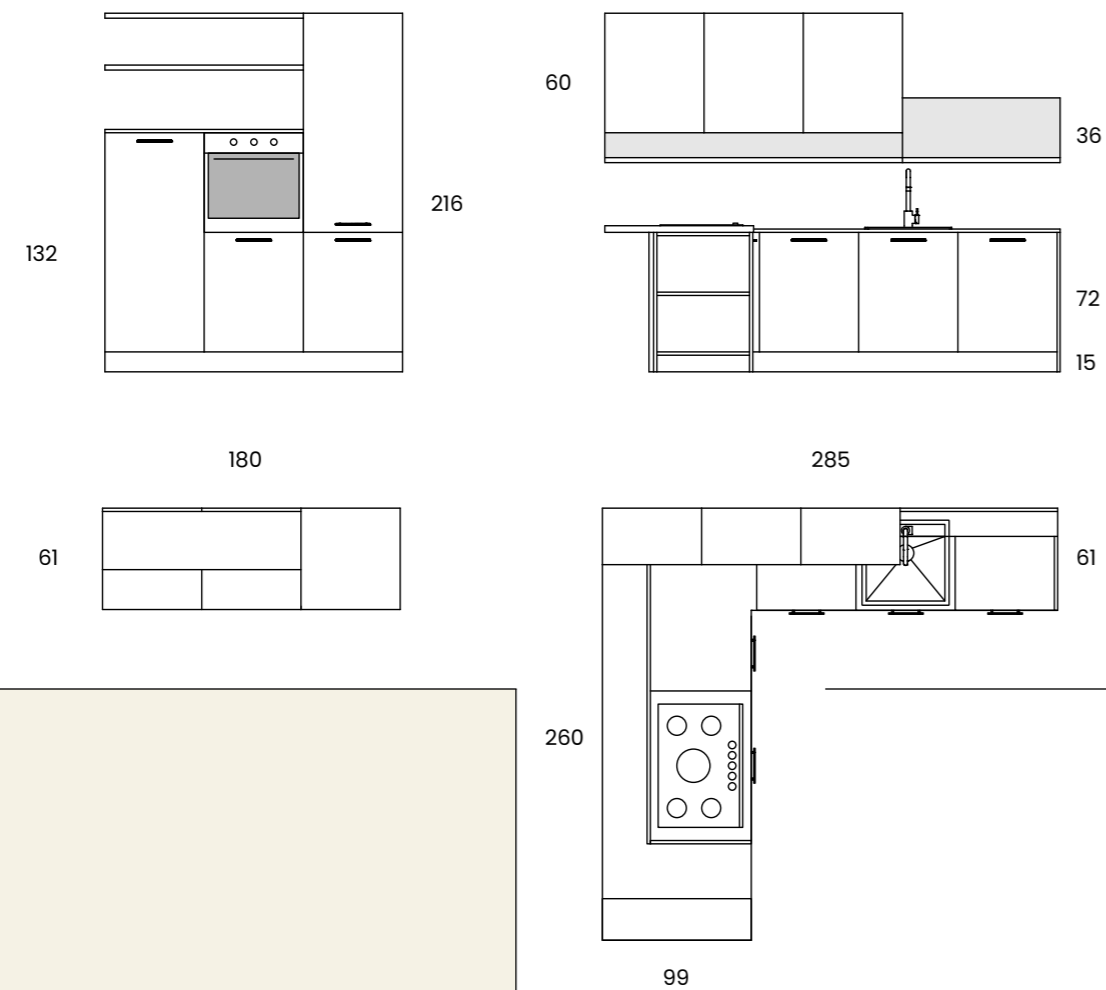

Bianco soft

Smoke grey

## Finiture

Ante colonne  
Termostrutturato legno materico - Tropea

Ante basi  
Nobilitato opaco Matt chic - Smoke grey

Ante pensili  
Nobilitato opaco Matt chic - Bianco soft

Worktop in laminato sp. 2 cm - Petra  
Worktop in laminato sp. 4 cm - Rovere primitivo

Maniglia - Square nero opaco  
Zoccolo h 15 PVC verniciato - Nero opaco

## Finishes

Tall unit doors  
Wood effect thermostructured - Tropea

Base cabinet doors  
Matt chic melamine - Smoke grey

Wall unit doors  
Matt chic melamine - Bianco soft

Worktop in Laminate sp. 2 cm - Petra  
Worktop in laminate 4 cm - Rovere primitivo

Handle - Square matt black finish  
Plinth h 15 painted PVC - Nero opaco

## Acabados

Portes colonnes  
Termoestructurado mäterico madera - Tropea

Puertas de bajos  
Melamina mate Matt chic - Smoke grey

Puertas de altos  
Melamina mate Matt chic - Bianco soft

Encimeras de laminado sp. 2 cm - Petra  
Encimeras de laminado sp. 4 cm - Rovere primitivo

Tirador Square - acabado negro mate  
Rodapiés h 15 PVC barnizado - Nero opaco

## Finitions

Portes colonnes  
Thermostructuré bois texturé - Tropea

Portes meubles bas  
Bois amélioré mat Matt chic - Smoke grey

Portes meubles hauts  
Bois amélioré mat Matt chic - Bianco soft

Plateaux en laminé 2 cm - Petra  
Plateaux en laminé 4 cm - Rovere primitivo

Pogne Square - finition noir mat  
Plinthes h 15 PVC peint - Nero opaco

# Kaya 03

art house

Petra

Tropea

Siena

L'isola diventa centro di lavoro e condivisione

# Kaya 04

Un modello attento alle esigenze dell'abitare contemporaneo, dove gli spazi si fondono e zona operative diventano luoghi conviviali dove svolgere le attività quotidiane. L'isola predomina la scena, se da un lato è completamente adibita a cucina dall'altro si apre al living con sedute e vani a giorno, le colonne completano lo scenario svuotandosi e dando luogo ad un inedito sistema di ripiani.

A model fokused to the needs of contemporary living, where operative areas become convivial spaces to carry out daily activities. The island dominates the scene, if on one side it is completely used as a kitchen, on the other it opens to the living room with seats and open compartments, the columns complete the scenario by emptying themselves and giving rise to an unprecedented system of shelves.

Un modelo que está atento a las necesidades de la vida contemporánea, donde las áreas operativas se convierten en lugares de convivencia en los que llevar a cabo las actividades diarias. La isla domina la escena, si por un lado se utiliza como cocina, por el otro se abre al salón con asientos y compartimentos abiertos, las columnas completan el escenario vaciándose y dando lugar a un inédito sistema de estanterías.

Un modèle attentif aux besoins de la vie contemporaine, où les zones opérationnelles deviennent des lieux conviviaux pour mener à bien les activités quotidiennes. L'îlot domine la scène, si d'un côté il sert entièrement de cuisine, de l'autre il s'ouvre sur le salon avec des assises et des compartiments ouverts, les colonnes complètent le scénario en se vidant et donnant naissance à un système d'étagères inédit.







## Kaya 04

Boiserie Unico con pali in alluminio nero opaco e ripiani in legno Rovere Cortina. Ante a vetro Ella con telaio in alluminio nero opaco e vetro fumé.

Unico boiserie with matt black aluminum poles and Rovere Cortina wooden shelves. Ella glass doors with matt black aluminium frame and fumé glass.

Boiserie Unico con varillas de aluminio negro mate y baldas de madera Rovere Cortina. Puertas de cristal Ella con marco de aluminio negro mate y cristal ahumado.

Boiserie Unico avec poteaux en aluminium noir mat et étagères en bois Rovere Cortina. Portes en verre Ella avec cadre en aluminium noir mat et verre fumé.



Tavolo Krono con struttura nera e piano in melaminico Antracite. Sedie Tata young con struttura e seduta in finitura nero opaco.

Krono table with black structure and Antracite melamine top. Tata young chairs with structure and seat matt black finish.

Mesa Krono con estructura negra y tapa de melamina Antracite. Silla Tata young con estructura y asiento negra mate.

Table Krono avec structure noire et plateau en mélaminé Antracite. Chaises Tata young avec structure et assise noire mat.

### Dettagli composizione

Composition details   Detalles de composición   Détails de la composition

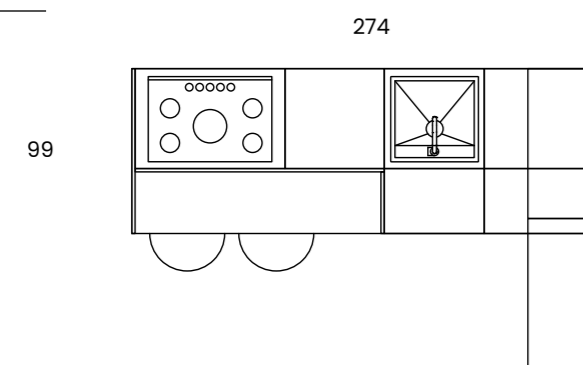
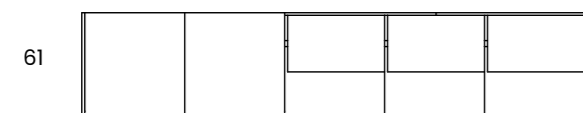
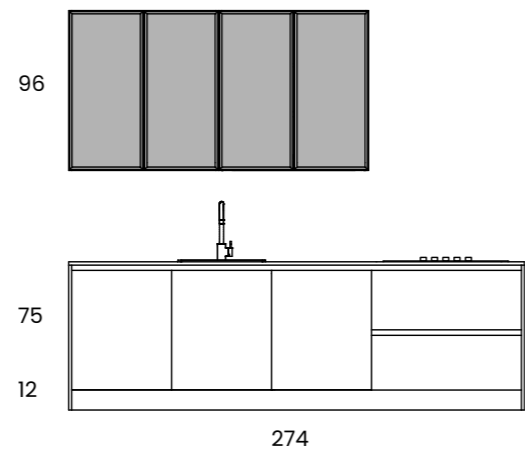
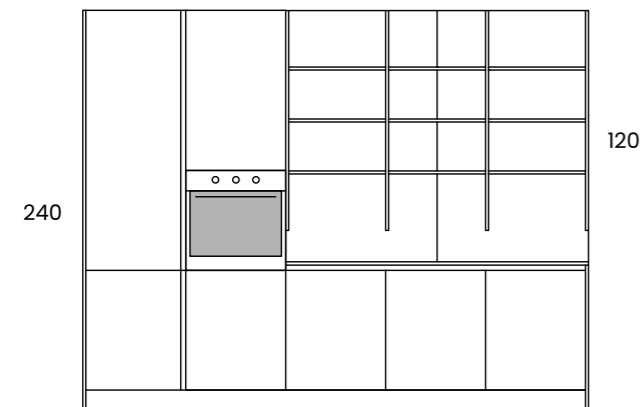

### Finiture

Ante colonne  
Nobilitato opaco Matt chic - Brio

Ante basi  
Termostrutturato legno materico - Rovere Cortina

Ante pensili  
Telaio alluminio nero opaco e vetro fumé

Worktop in laminato sp. 2 cm - Alicante

Gola scavata - Nero opaco  
Zoccolo h 12 PVC verniciato - Nero opaco

### Finishes

Tall unit doors  
Matt chic melamine - Brio

Base cabinet doors  
Wood effect thermostructured - Rovere Cortina

Wall unit doors  
Black matt aluminum frame and fumé glass

Worktop in Laminat sp. 2 cm - Alicante

Groove recessed - Nero opaco  
Plinth h 12 painted PVC - Nero opaco

### Acabados

Portes colonnes  
Melamina mate Matt chic - Brio

Puertas de bajos  
Termoestructurado matérico madera - Rovere Cortina

Puertas de altos  
Marco de aluminio negro mate y cristal ahumado

Encimeras de laminado sp. 2 cm - Alicante

Perfil tirador excavado - Nero opaco  
Rodapiés h 12 PVC barnizado - Nero opaco

### Finitions

Portes colonnes  
Bois amélioré mat Matt chic - Brio

Portes meubles bas  
Thermostructuré bois texturé - Rovere Cortina

Portes meubles hauts  
Cadre en aluminium noir mat et verre fumé

Plateaux en laminé 2 cm - Alicante

Gorge creusée - Nero opaco  
Plinthes h 12 PVC peint - Nero opaco

# Kaya 04

art house

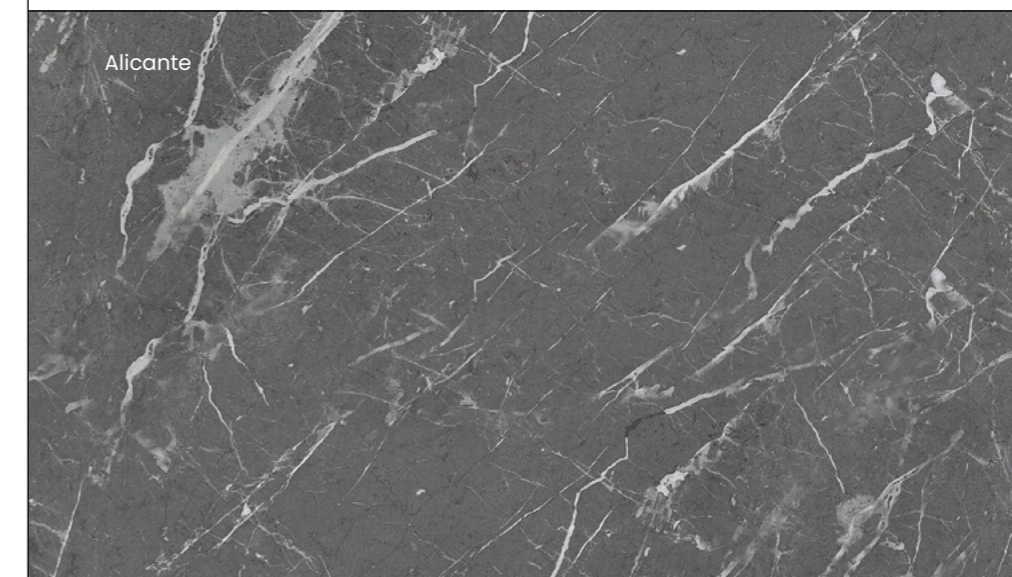



Sveva 02

Il fascino di un gusto romantico e senza tempo

## Sveva 02

La voglia di ritorno al passato riecheggia in questo ambiente, dove le ante telaio Sveva donano una piacevole e romantica armonia all'intera composizione. Le forme lineari della cucina si innestano perfettamente nello spazio, a destra si sviluppano zona lavaggio e cottura in un angolo e sono intervallate da dettagli in legno, mentre a sinistra le colonne generano un'ulteriore zona lavoro.

This kitchen speaks to us of nostalgia for time gone by Sveva framed doors add a pleasant, romantic harmony to the whole composition. The linear forms of the kitchen adapt perfectly to the shape of the room. Washing and cooking areas extend into the right corner, separated by wood details, while tall units form another work area to the left.

Evoca un deseo de volver al pasado este ambiente, donde las puertas con marco Sveva aportan una agradable y romántica armonía a toda la composición. Las formas lineales de la cocina se integran a la perfección en el espacio. A la derecha puede verse el rincón de la zona de lavado y cocción intercalada por detalles en madera, mientras que a la izquierda las columnas crean otra zona operativa.

Le désir d'un retour au passé trouve un écho dans cet environnement où les portes à cadre Sveva confèrent une harmonie agréable et romantique à toute la composition. Les formes linéaires de la cuisine s'intègrent parfaitement dans l'espace. À droite, la zone lavage et cuisson est aménagée dans un coin et entrecoupée de détails en bois, alors qu'à gauche, les colonnes créent une zone de travail supplémentaire.







Sveva 02



## Sveva 02

Maniglia modello Dorica finitura Titanio. Mensole nobilitato white e pannello uso schienale in legno termostrutturato finitura Noce Svezia.

Dorica handle in Titanium finish. White melamine shelves and splashback panel in thermo-structured wood with a Noce Svezia finish.

Tirador modelo Dorica, acabado Titanium. Estantes melamina blanco y panel de pared en madera termoestructurada, acabado Noce Svezia.

Poignée modèle Dorica finition Titanium. Étagères amélioré blanche et panneau de crédence en bois termostructuré, finition Noce Svezia.



Tavolo Mikado con struttura Grafite e piano in vetro trasparente. Sedia Lantana con struttura metallo nero opaco e seduta cuoio Cognac.

Mikado table with Grafite frame and clear glass top. Lantana chair with matte black frame and Cognac leather seat.

Mesa Mikado con estructura Grafite y tablero de cristal transparente. Silla Lantana con estructura metálica Negro mate y asiento de cuero Cognac.

Table Mikado avec structure Grafite et plateau en verre transparent. Chaise Lantana avec structure en métal noir mat et assise en cuir Cognac.

## Dettagli composizione

Composition details Detalles de composición Détails de la composition



### Finiture

Ante colonne  
Sveva Alkorcell - White matt

Ante basi  
Sveva Alkorcell - White matt

Ante pensili  
Sveva Alkorcell - White matt

Worktop in quarzo sp. 3 cm  
Betulla

Maniglia - Dorica titanium  
Zoccolo h 15 PVC verniciato - Bianco opaco

### Finishes

Tall unit doors  
Sveva Alkorcell - White matt

Base cabinet doors  
Sveva Alkorcell - White matt

Wall unit doors  
Sveva Alkorcell - White matt

Worktop in quartz sp. 3 cm  
Betulla

Handle - Dorica titanium  
Plinth h 15 painted PVC - White matt

### Acabados

Portes colonnes  
Sveva Alkorcell - White matt

Puertas de bajos  
Sveva Alkorcell - White matt

Puertas de altos  
Sveva Alkorcell - White matt

Encimeras de cuarzo sp. 3 cm  
Betulla

Tirador Dorica - acabado titanio  
Rodapiés h 15 PVC barnizado - Blanco opaco

### Finitions

Portes colonnes  
Sveva Alkorcell - White matt

Portes meubles bas  
Sveva Alkorcell - White matt

Portes meubles hauts  
Sveva Alkorcell - White matt

Plateaux en quartz sp. 3 cm  
Betulla

Poigné Dorica - finition titanio  
Plinthes h 15 PVC peint - Nero opaco

# Sveva 02

art house

White matt

Noce Svezia

Betulla

Linee che si inseguono in uno spazio di autentica convivialità

# Kaya 05

La principale caratteristica di Kaya è quella di sapersi plasmare a seconda dell'ambiente e delle esigenze, così da creare infinite soluzioni progettuali e spazi completi dove l'uomo viene posto sempre al centro. Una composizione dove tutte le funzioni sono concentrate in una penisola, che da un lato accoglie le colonne tecniche, mentre dall'altro offre un comodo piano snack per i momenti di condivisione.

Kaya has a unique ability to adapt to any space. This kitchen can create an infinity of design solutions and complete spaces in which people always play the leading role. In this composition, all functionality is concentrated in a peninsula that houses the tall units and appliances on one side and forms a practical snack top for those shared moments on the other.

La característica principal de Kaya es la de saber plasmarse en base al ambiente y a las necesidades para crear infinitas soluciones proyectivas y espacios completos que giran siempre alrededor de las personas. Una composición donde todas las funciones se concentran en una península, que de un lado contiene las columnas técnicas y del otro una cómoda barra snack para los momentos compartidos.

La principale caractéristique de Kaya est de savoir se modeler en fonction de l'environnement et des exigences, afin de créer un nombre infini de solutions conceptuelles et des espaces complets qui mettent toujours au centre l'humain. Une composition où toutes les fonctions sont concentrées dans une presqu'île qui accueille les colonnes techniques d'un côté et qui, de l'autre côté, offre un plan snack pratique pour les moments de partage.



Kaya 05





## Kaya 05

Pensile Jolly nobilitato opaco in finitura Smoke grey. Anta colonne con maniglia Matrix a tutta altezza finitura nero opaco.

Jolly wall unit in matte Smoke Grey melamine. Tall unit doors with full-height Matrix handle in matte Nero finish.

Alto Jolly en melamina mate, acabado Smoke grey. Frentes de columna con tirador Matrix vertical a todo lo largo, acabado Negro mate.

Meuble haut Jolly en bois amélioré mat finition Smoke grey. Porte des colonnes à toute hauteur avec poignée Matrix et finition nero mat.





Tavolo Krono con struttura nera e piano in melaminico Antracite. Sedie Tata young con struttura e seduta in finitura Tortora opaco.

Krono table with black frame and melamine top in Antracite finish. Tata Young chairs with frame and seat in matte Tortora.

Mesa Krono con estructura color Negro y tablero en melamina Antracite. Sillas Tata young con estructura y asiento en acabado Tortora mate.

Table Krono avec une structure noire et un plateau en mélaminé Antracite. Chaises Tata young avec structure et assise finition Tortora mat.

### Dettagli composizione

Composition details Detalles de composición Détails de la composition

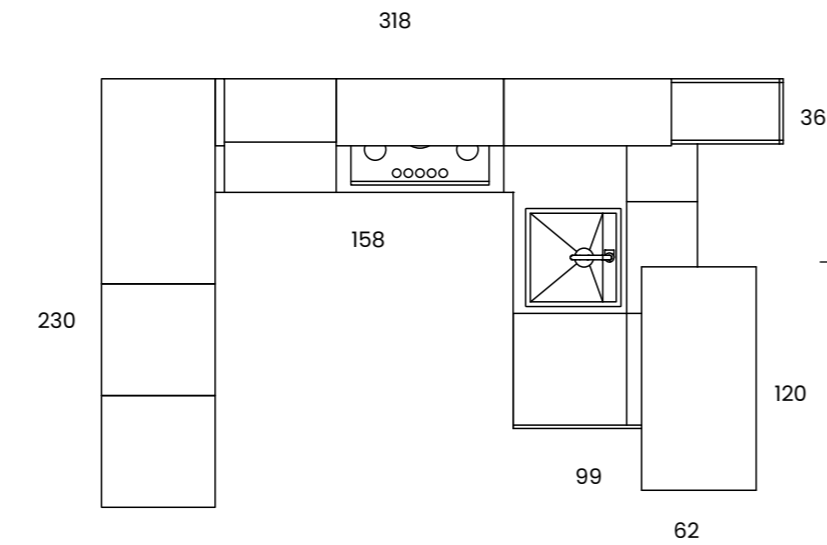
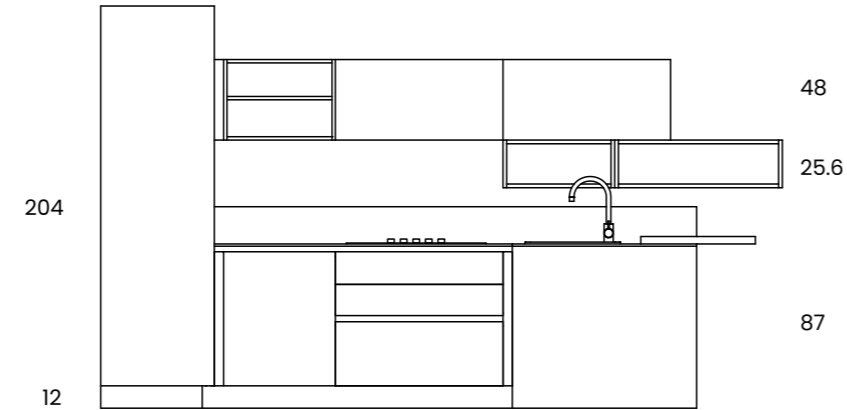
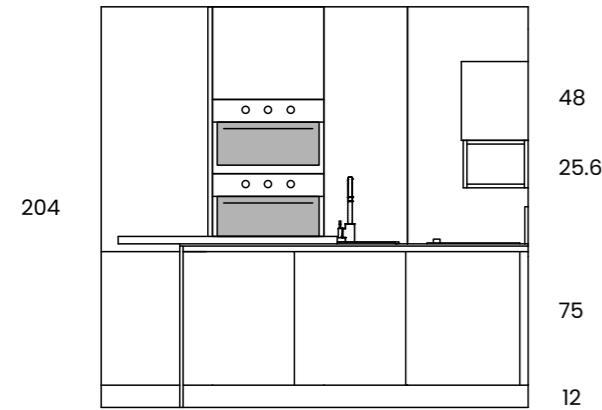

### Finiture

Ante colonne  
Termostrutturato legno materico - Cordoba

Ante basi  
Nobilitato opaco Matt chic - Conchiglia

Ante pensili  
Nobilitato opaco Matt chic - Smoke grey

Worktop in gres Neolith sp. 12 cm - Pietra di luna  
Piano snack in laminato sp. 4 cm - Pulipis dark

Gola scavata - Nero opaco  
Zoccolo h 12 PVC verniciato - Nero opaco

### Finishes

Tall unit doors  
Wood effect thermostructured - Cordoba

Base cabinet doors  
Matt chic melamine - Conchiglia

Wall unit doors  
Matt chic melamine - Smoke grey

Worktop in gres 12 cm - Pietra di luna  
Plain in Laminato sp. 4 cm - Pulipis dark

Groove recessed - Nero opaco  
Plinth h 12 painted PVC - Nero opaco

### Acabados

Portes colonnes  
Termoestructurado mäterico madera - Cordoba

Puertas de bajos  
Melamina mate Matt chic - Conchiglia

Puertas de altos  
Melamina mate Matt chic - Smoke grey

Encimeras de gres 12 cm - Pietra di luna  
Mesa de laminado sp. 4 cm - Pulipis dark

Perfil tirador excavado - Nero opaco  
Rodapiés h 12 PVC barnizado - Nero opaco

### Finitions

Portes colonnes  
Thermostructuré bois texturé - Cordoba

Portes meubles bas  
Bois amélioré mat Matt chic - Conchiglia

Portes meubles hauts  
Bois amélioré mat Matt chic - Smoke grey

Plateaux en gres 12 cm - Pietra di luna  
Dessus de la table en laminé 4 cm - Pulipis dark

Gorge creusée - Nero opaco  
Plinthes h 12 PVC peint - Nero opaco

# Kaya 05

art house

Conchiglia

Cordoba

Smoke grey

Pietra di luna

Pulipis dark



Un rifugio fatto di volumi materici che si intersecano tra loro

# Kaya 06

Ogni materiale della collezione Kaya contribuisce a rendere un ambiente unico ed inimitabile, così le eleganti superfici lignee si mescolano al rigoroso effetto pietra. Una composizione ad angolo chiusa sui due lati concentra tutte le principali funzioni, è caratterizzata da vani a giorno e pensili che si compenetrano dando luogo a nuovi spazi per l'organizzazione domestica.

The materials selected for the Kaya collection create a unique and inimitable environment in which elegant wood surfaces are offset by a rigorous stone effect finish. A corner composition enclosed on both sides houses all the main functions and is characterised by inter-penetrating open compartments and wall units that create original spaces for domestic storage.

Cada material de la colección Kaya contribuye a crear un espacio único e inimitable, donde las elegantes superficies de madera se funden con el sobrio efecto piedra. Una composición en contera cerrada de ambos lados concentra las funciones principales, donde los módulos abiertos y los altos se compenetran dando lugar a nuevos espacios para la organización doméstica.

Chaque matériau de la collection Kaya participe à rendre l'environnement unique et inimitable, ainsi les surfaces élégantes en bois se combinent avec l'effet pierre rigoureux. Une composition d'angle fermée sur deux côtés concentre les fonctions principales. Elle se caractérise par des compartiments ouverts et des meubles hauts qui s'imbriquent pour créer de nouveaux espaces destinés à l'organisation ménagère.







## Kaya 06

Boiserie Unico con pali in alluminio nero opaco e ripiani in legno Noce Svezia. Colonna Jolly in legno termostrutturato finitura Noce Svezia.

Unico boiserie with matte black aluminium pillars and Noce Svezia wood shelves. Jolly tall unit in thermo-structured wood with a Noce Svezia finish.

Boiserie Unico con montantes en aluminio Negro mate y baldas en madera Noce Svezia. Columna Jolly en madera termoestructurada, acabado Noce Svezia.

Boiserie Unico avec des montants en aluminium noir mat et des étagères en bois Noce Svezia. Colonne Jolly en bois thermostructuré, finition Noce Svezia.





Tavolo Plutone con struttura nera e piano in melaminico Antracite. Sedie Eva con struttura e seduta nero opaco.

Plutone table with black structure and Antracite melamine top. Eva chairs with matt black structure and seat.

Mesa Plutone con estructura negra y tapa de melamina Antracite. Silla Eva con estructura y asiento negro mate.

Table Plutone avec structure noire et plateau en mélaminé Antracite. Chaises Eva avec structure et assise noire mat.

## Dettagli composizione

Composition details Detalles de composición Détails de la composition

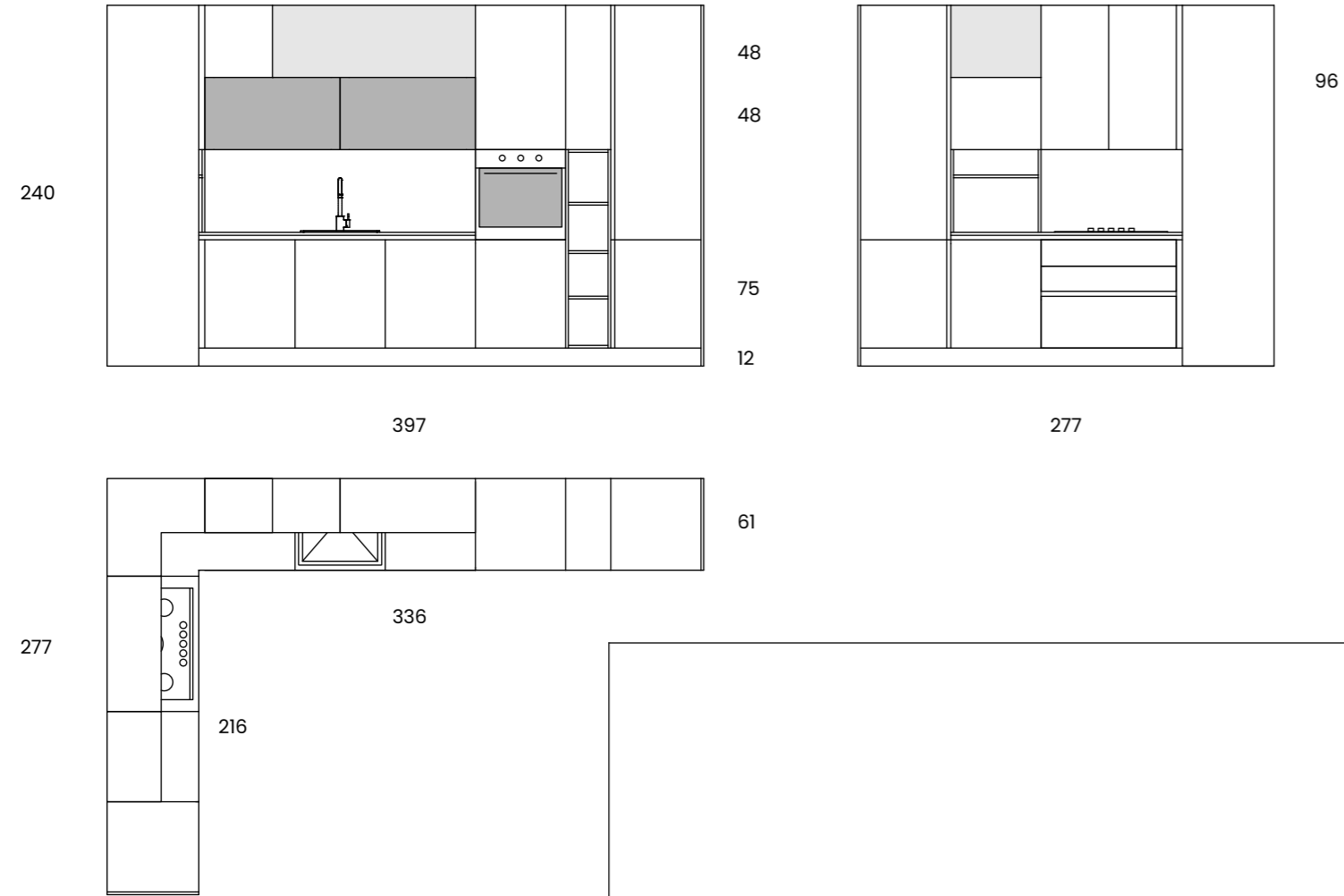

### Finiture

Ante colonne  
Cemento materico - Sand

Ante basi  
Cemento materico - Sand

Ante pensili  
Termostutturato legno materico - Noce Svezia  
Nobilitato opaco Matt chic - Ink

Worktop in laminato sp. 2 cm - Pulipis dark  
Schienale - Pulipis dark

Gola scavata - Nero opaco  
Zoccolo h 12 PVC verniciato - Nero opaco

### Finishes

Tall unit doors  
Concrete effect - Sand

Base cabinet doors  
Concrete effect - Sand

Wall unit doors  
Wood effect thermostructured - Noce Svezia  
Matt chic melamine - Ink

Worktop in Laminate sp. 2 cm - Pulipis dark  
Backsplash - Pulipis dark

Groove recessed - Nero opaco  
Plinth h 12 painted PVC - Nero opaco

### Acabados

Portes colonnes  
Matérico cemento - Sand

Puertas de bajos  
Matérico cemento - Sand

Puertas de altos  
Termoestructurado matérico madera - Noce Svezia  
Melamina mate Matt chic - Ink

Encimeras de laminado sp. 2 cm - Pulipis dark  
Espalda - Pulipis dark

Perfil tirador excavado - Nero opaco  
Rodapiés h 12 PVC barnizado - Nero opaco

### Finitions

Portes colonnes  
Cemento texture - Sand

Portes meubles bas  
Cemento texture - Sand

Portes meubles hauts  
Thermostructuré bois texturé - Noce Svezia  
Bois amélioré mat Matt chic - Ink

Plateaux en laminé 2 cm - Pulipis dark  
Retour - Pulipis dark

Gorge creusée - Nero opaco  
Plinthes h 12 PVC peint - Nero opaco

# Kaya 06

art house

Pulipis dark

Noce Svezia

Sand

Ink



La sintesi perfetta tra rigore e fascino metropolitano

## Sveva 03

Sveva è qui raccontata in un'atmosfera dal sapore metropolitano ma con il rigore estetico proprio dell'intera collezione. La sua particolare tonalità scura le dona eleganza e fascino, l'isola spicca al centro della stanza e padrona la scena con il suo piano in legno a sbalzo, tutt'attorno si sviluppano volumi a varie altezze per soddisfare dalle esigenze tecniche a quelle ergonomiche.

This Sveva composition expresses an atmosphere of metropolitan charm accompanied by the collection's characteristic rigour of style. A striking, dark tone adds elegance and character. The island in the centre of the room dominates the scene with its cantilever wood top. All around, volumes of various heights satisfy the kitchen's technical and ergonomic requirements.

Sveva se interpreta aquí en un ambiente de gusto metropolitano, pero con la sobriedad estética típica de toda la colección. Su particular tonalidad oscura le aporta elegancia y encanto, mientras la isla se destaca en el centro del ambiente dominando la escena con su tablero saledizo de madera y alrededor se despliegan volúmenes de varias alturas para responder a las pautas técnicas y ergonómicas.

Sveva est ici représentée dans une ambiance au goût métropolitain, mais avec la rigueur esthétique caractéristique de toute la collection. Sa nuance foncée particulière lui confère charme et élégance. Au milieu de la pièce, l'îlot ressort et domine la scène avec son plateau en bois en porte-à-faux. Tout autour, des volumes se développent à différentes hauteurs pour satisfaire les exigences à la fois techniques et ergonomiques.





Sveva 03



## Sveva 03

Worktop in laminato legno finitura Rovere anice. Sgabelli modello Tata young con struttura e seduta in finitura nero opaco.

Worktop in Rovere Anice wood laminate. Tata Young stools with frame and seat in matte Nero.

Encimera en laminado madera, acabado Rovere anice. Taburetes Tata young con estructura y asiento en acabado Nero mate.

Plan de travail en bois stratifié finition Rovere anice. Tabourets modèle Tata young avec une structure et une assise finition nero mat.







Pensile Jolly in cemento materico finitura Sand. Boiserie Unico con pali in alluminio nero opaco e ripiani in cemento materico Sand.

Jolly wall unit in Sand textured cement finish. Unico boiserie with matte black aluminium pillars and Sand textured cement shelves.

Alto Jolly en cemento matérico, acabado Sand. Boiserie Unico con montantes en aluminio Negro mate y baldas en cemento matérico Sand.

Meuble haut Jolly en cemento texturé finition Sand. Boiserie Unico avec des montants en aluminium noir mat et des étagères en cemento texturé Sand.

## Dettagli composizione

Composition details Detalles de composición Détails de la composition

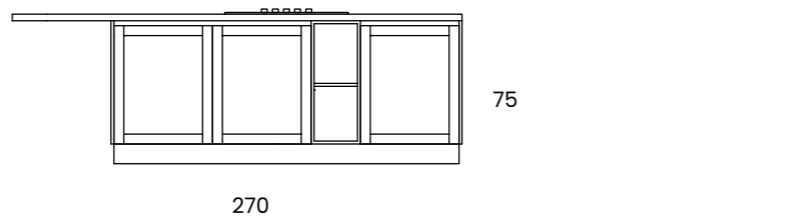
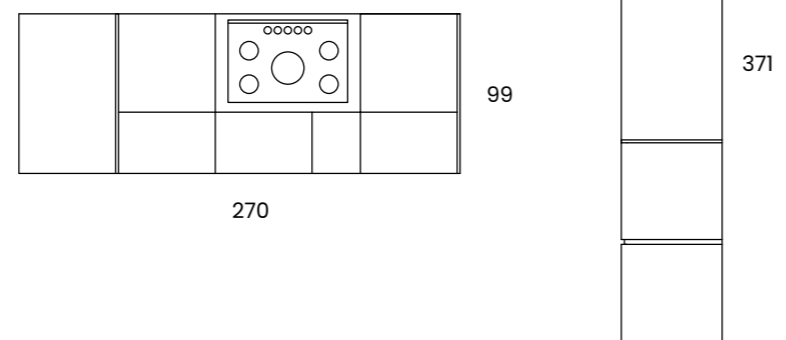
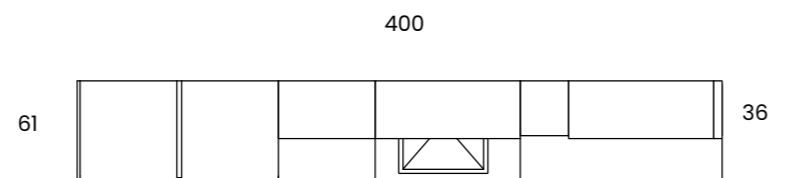
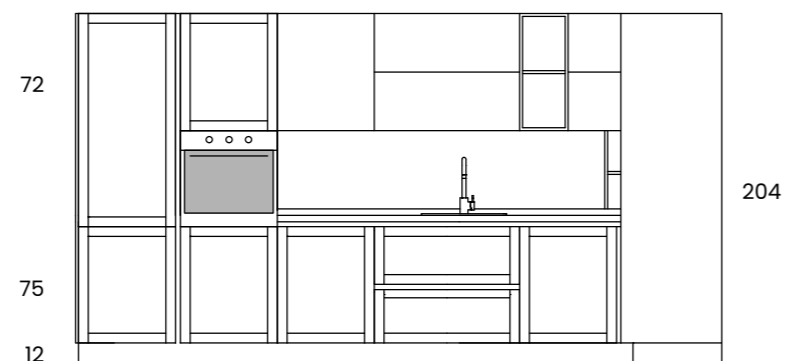
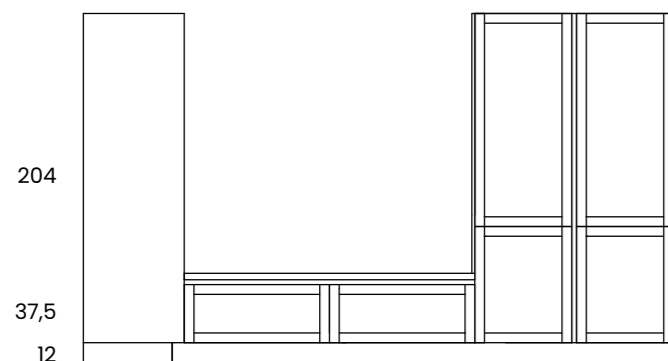

### Finiture

Ante colonne  
Sveva Alkorcell - Black matt

Ante basi  
Sveva Alkorcell - Black matt

Ante pensili  
Cemento materico - Sand

Worktop in laminato sp. 4 cm - Lava  
Worktop in laminato sp. 4 cm - Rovere anice

Gola scavata - Nero opaco  
Zoccolo h 15 PVC verniciato - Nero opaco

### Finishes

Tall unit doors  
Sveva Alkorcell - Black matt

Base cabinet doors  
Sveva Alkorcell - Black matt

Wall unit doors  
Materic concrete - Sand

Worktop in laminate sp. 4 cm - Lava  
Worktop in laminate sp. 4 cm - Rovere anice

Groove recessed - Nero opaco  
Plinth h 15 painted PVC - Nero opaco

### Acabados

Portes colonnes  
Sveva Alkorcell - Black matt

Puertas de bajos  
Sveva Alkorcell - Black matt

Puertas de altos  
Matérico cemento - Sand

Encimeras de laminado sp. 4 cm - Lava  
Encimeras de laminado sp. 4 cm - Rovere anice

Perfil tirador excavado - Nero opaco  
Rodapiés h 15 PVC barnizado - Nero opaco

### Finitions

Portes colonnes  
Sveva Alkorcell - Black matt

Portes meubles bas  
Sveva Alkorcell - Black matt

Portes meubles hauts  
Cemento texture - Sand

Plateaux en laminé 4 cm - Lava  
Plateaux en laminé 4 cm - Rovere anice

Gorge creusée - Nero opaco  
Plinthes h 15 PVC peint - Nero opaco

# Sveva 03

art house

Black matt

Sand

Rovere anice

Lava

**ART**

**Technical data**

L'attenzione rivolta ai dettagli tecnici ed estetici delle varie componenti dei modelli della linea Art è nata dall'immaginazione di poter dare il meglio in fatto di qualità, funzionalità e design ad un costo straordinariamente competitivo. In Art l'immaginazione si è fatta realtà affiancando ricerca ed esperienza, rigore progettuale e creatività, il made in Italy con i valori di un grande brand come Stosa Cucine.

The attention we pay to the technical and stylistic details of every component of Art line furniture stems from our determination to offer the very best in terms of quality, functionality and design at an extraordinarily competitive price.

In Art Line furniture, this determination is expressed through research and experience, rigorous design and creativity, Italian flair and the values of the great Stosa Cucine brand.

La atención por los detalles técnicos y estéticos de los varios componentes de los modelos de la línea Art nace de la imaginación de poder alcanzar la excelencia en materia de calidad, funcionalidad y diseño a un precio extremadamente competitivo. En Art, la imaginación se vuelve realidad junto con el estudio y la experiencia, el rigor proyectivo y la creatividad, la excelencia de la producción italiana y los valores de una gran marca como Stosa Cucine.

L'attention portée aux détails techniques et esthétiques des différents accessoires des modèles de la ligne Art est née du désir d'offrir le meilleur en termes de qualité, de fonctionnalité et de design à un coût extraordinairement compétitif. Dans Art ce désir est devenu réalité en combinant la recherche et l'expérience, la rigueur conceptuelle et la créativité, le Made in Italy et les valeurs d'une grande marque comme Stosa Cucine.



## Tipologia ante

Doors type Tipología de Puertas Typologie Portes

### Kaya \_Anta liscia sp. 18 mm

Con profil raggiato r. 1 mm nei quattro lati.



Slab door th. 18 mm with 1 mm radiused profile on all four sides.  
Puerta lisa esp. 18 mm con canto radio 1 mm en los cuatro lados.  
Porte lisse ép. 18 mm avec profil quart-de-rond r. 1 mm des quatre côtés.

### Sveva \_Anta a telaio sp. 18 mm

Con profilo raggiato r. 0,5 mm nei quattro lati.



Shaker door th. 18 mm with 0.5 mm radiused profile on all four sides.  
Puerta con bastidor esp. 18 mm con canto radio 0.5 mm en los cuatro lados.  
Porte à cadre ép. 18 mm avec profil quart-de-rond r. 0.5 mm des quatre côtés.



### Ella \_anta vetro sp. 18 mm new

Anta in alluminio nero opaco e vetro Fumè  
Aluminium frame door th. 18 mm with Fumè glass.  
Puerta con marco de aluminio de 18 mm con cristal Fumè.  
Porte à cadre en aluminium épaisseur 18 mm avec verre Fumè.

## Tipologia ante

Doors type Tipología de Puertas Typologie Portes

### Lumia \_Anta lacc. opaco 5 lati sp. 18 mm new

Con retro in tinta.



Slab door th. 18 mm 5-sided matt lacquered with tone-on-tone back side.  
Puerta lisa esp. 18 mm Laca mate 5 caras con reverso tono sobre tono.  
Porte lisse ép. 18 mm Laque mate 5 faces avec dos ton sur ton.

### Lumia \_Anta lacc. lucida sp. 18 mm new

Con retro in tinta.



Slab door th. 18 mm 5-sided glossy lacquered with tone-on-tone back side.  
Puerta lisa esp. 18 mm Laca brillante 5 caras con reverso tono sobre tono.  
Porte lisse ép. 18 mm Laque brillante 5 faces avec dos ton sur ton.

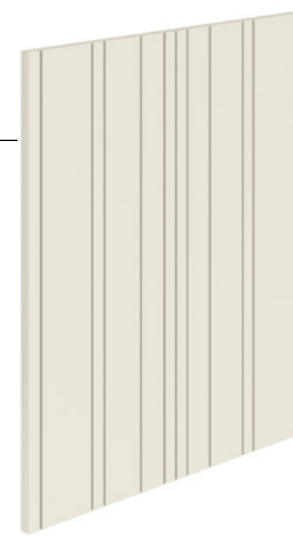

### Lumia \_Anta lacc. opaco traccia sp. 18 mm new

Con retro liscio in tinta.

Ribbed door th. 18 mm 5-sided matt lacquered with tone-on-tone back side.  
Puerta acanalada esp. 18 mm Laca mate 5 caras con reverso tono sobre tono.  
Porte côtelée ép. 18 mm Laque mate 5 faces avec dos ton sur ton.

# Tipologia aperture

Opening system   Sistemas de apertura   Systèmes d'ouverture

## King

Pomolo Knob Pomo Pommeau

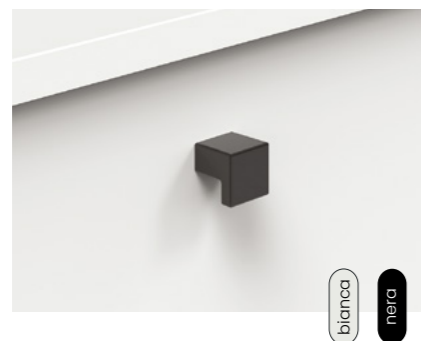

bianca  
nera

## King

Interasse 160 Center distance 160 mm  
Distancia agujeros 160 mm   Entraxe 160 mm



bianca  
nera

## Slim

Interasse 160 Center distance 160 mm  
Distancia agujeros 160 mm   Entraxe 160 mm



nichel  
nera

## Pomolo Art

Pomolo Knob Pomo Pommeau



nichel  
nera

## Plinth

Interasse 160 Center distance 160 mm  
Distancia agujeros 160 mm   Entraxe 160 mm



nichel  
nera

## Dorica

Interasse 160 Center distance 160 mm  
Distancia agujeros 160 mm   Entraxe 160 mm



titanio  
nera

# Tipologia aperture

Opening system   Sistemas de apertura   Systèmes d'ouverture

## Brakets

Interasse 160 Center distance 160 mm  
Distancia agujeros 160 mm   Entraxe 160 mm



nichel  
nera

## Gola scavata

Recessed groove   Perfil tirador excavado  
Gorge creusée



bianca  
titanio  
nera

## Square

Interasse 160 Center distance 160 mm  
Distancia agujeros 160 mm   Entraxe 160 mm



nera

## Matrix

Maniglia per colonne   Handle for tall units  
Tiradora para columnas   Poignée pour colonnes



nichel  
nera

## Kaya \_Finiture anta liscia

Slab door finishes Acabados de puerta lisa Finitions de porte lisse

### Nobilitato opaco Matt chic 18mm

Matt chic melamine Melamina mate Matt chic Bois amélioré mat Matt chic

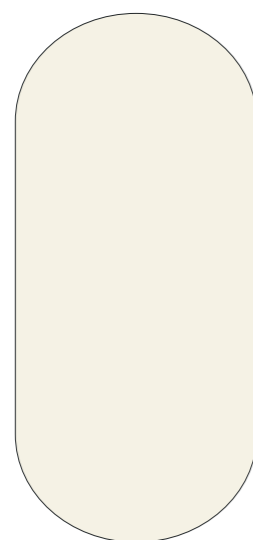

Bianco soft

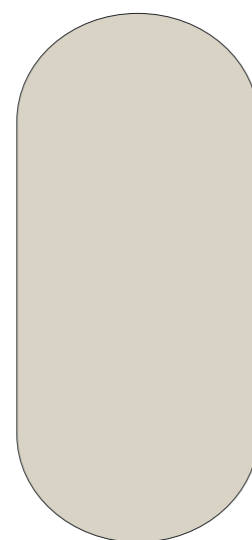

Conchiglia



Vanilla Ice

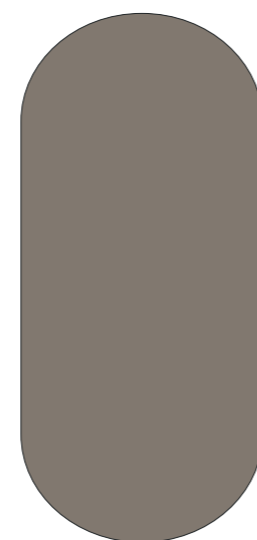

Smoke grey

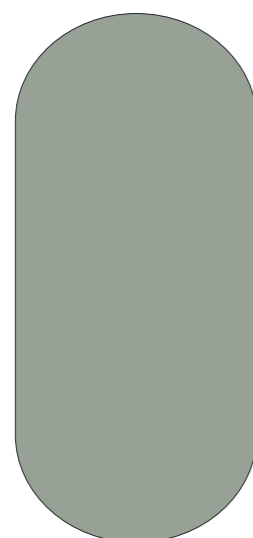

Brio

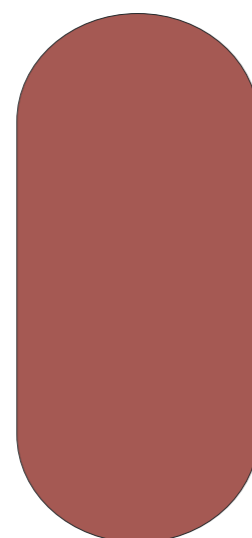

Siena



Ink

## Kaya \_Finiture anta liscia

Slab door finishes Acabados de puerta lisa Finitions de porte lisse

### Termostutturato legno materico 18mm

Wood effect thermostructured Termoestructurado matérico Thermostructuré bois texturé madera



Cordoba



Tropea



Noce Svezia



Rovere Cortina

## Kaya \_ Finiture anta liscia

Slab door finishes Acabados de puerta lisa Finitions de porte lisse

### Cemento materico 18mm

Cemento effect Matérico Cemento Cemento texture



Pola



Sand



Alu

### Ossido materico 18mm

Ossido effect Matérico Ossido Ossido texturé

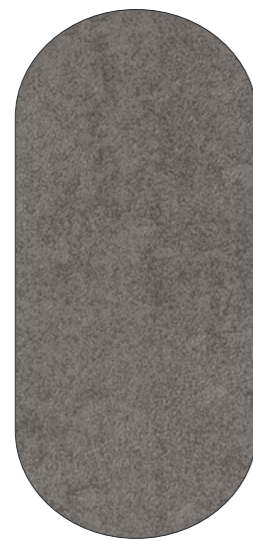

Slate grey

## Sveva \_ Finiture anta a telaio

Shaker door finishes Acabados de puerta con bastidor Finitions de porte à cadre

### Alkorcell 18mm

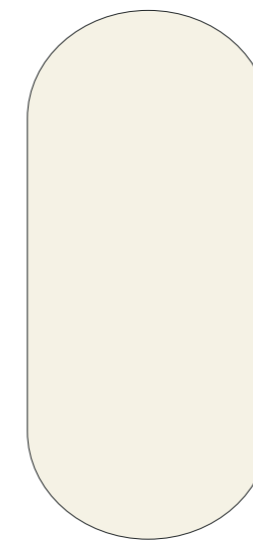

White matt



Black matt

## Lumia \_Finiture anta liscia

Slab door finishes Acabados de puerta lisa Finitions de porte lisse

### Laccato opaco/lucido 5 lati con retro in tinta 18mm

5-sided matt lacquered with tone-on-tone back side Laca mate 5 caras con reverso tono sobre tono Laque mate 5 faces avec dos ton sur ton

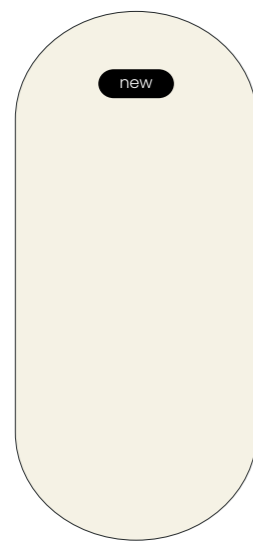

Milk white opaco

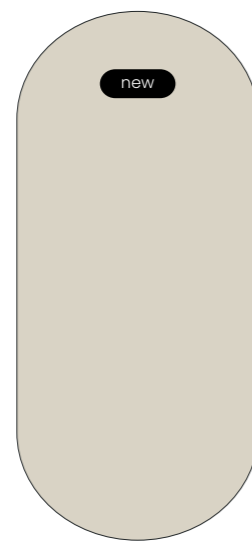

Cotton opaco



Cobalt grey opaco

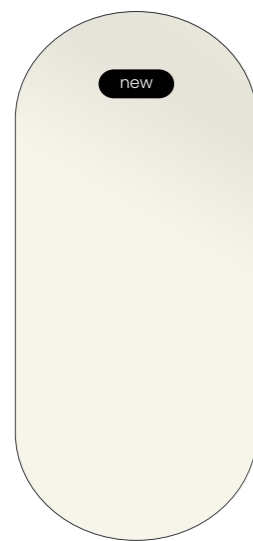

Milk white lucido

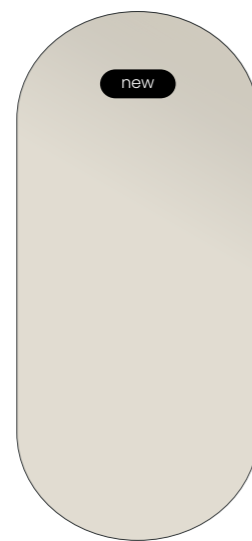

Cotton lucido



Cobalt grey lucido

## Lumia \_Finitura anta traccia

Slab door finishes Acabados de puerta lisa Finitions de porte lisse

### Laccato opaco 5 lati con retro in tinta 18mm

5-sided glossy lacquered with tone-on-tone back side Laca brillante 5 caras con reverso tono sobre tono Laque brillante 5 faces avec dos ton sur ton

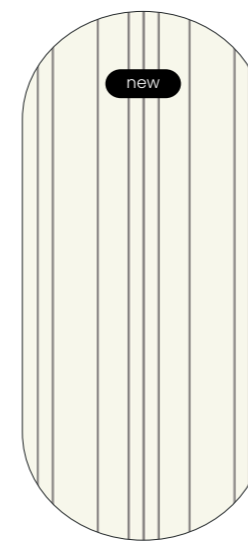

Milk white opaco traccia

### Dimensioni disponibili

available dimension tallas disponibles tailles disponibles

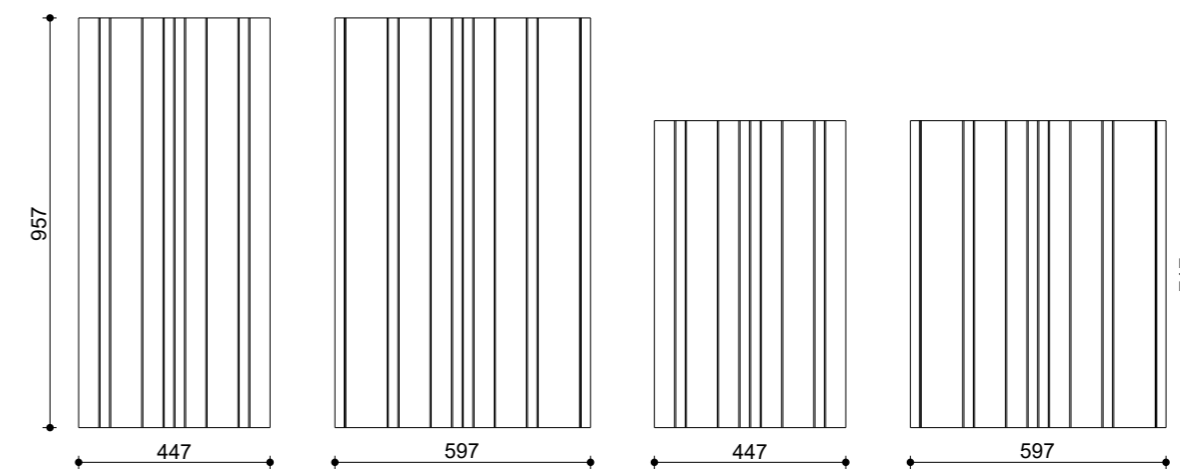



# Finitura anta vetro Ella

Glass door finish Acabado de puerta de cristal Finitions de porte en verre

Telaio in alluminio 22 mm new

Aluminium and Fumè glass Aluminio y vidrio Fumè Aluminium et verre Fumè



Nero opaco



Vetro Fumè

## Dimensioni disponibili

available dimension tallas disponibles tailles disponibles

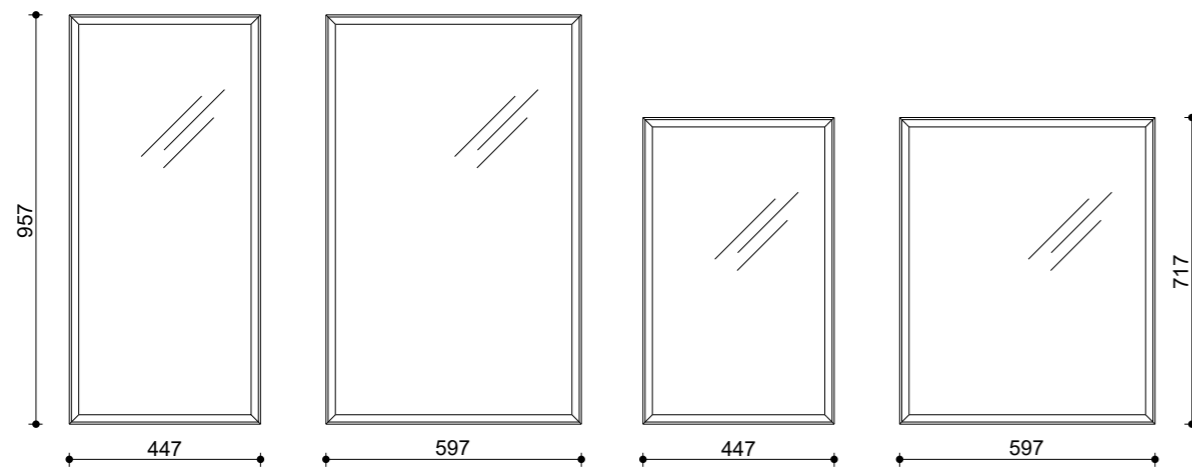

# Piani in laminato

Laminate worktops Encimeras de laminado Plateaux en laminé

Piano con bordo ABS in tinta sp. 2-4cm

Worktops with matching ABS Encimera con borde ABS a tono Plateau avec bord en ABS couleur assortie

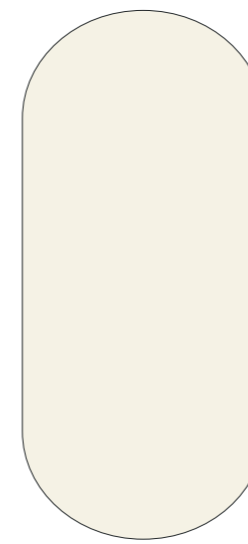

Bianco soft



Rovere primitivo



Fenice amon

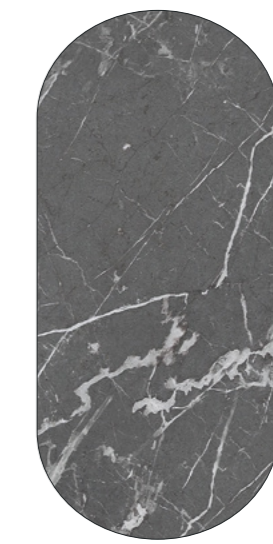

Alicante



Petra

## Piani in laminato

Laminate worktops Encimeras de laminado Plateaux en laminé

### Piano con bordo ABS in tinta sp. 2-4cm

Worktops with matching ABS Encimera con borde ABS a tono Plateau avec bord en ABS couleur assortie



Pola



Sand



Alu



Slate grey

## Piani in laminato

Laminate worktops Encimeras de laminado Plateaux en laminé

### Piano con bordo raggio 2 mm sp. 4 cm

Worktops with 2 mm radiusedmadera Worktops with 2 mm radiused Encimera con borde radio 2 mm Plateau avec bord rayon 2 mm



Corten sabbia



Pietra vecchia

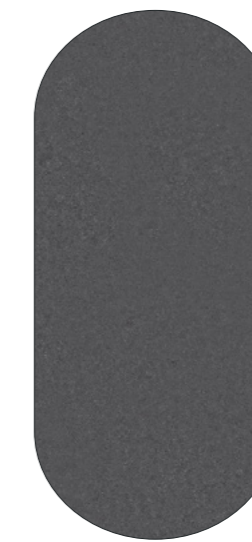

Lava

## Finiture zoccolo e gola

Plinth and groove finishes Perfil tirador excavado Acabados rodapiés  
Gorge creusée acabados rodapiés

### Zoccolo PVC verniciato h 12 cm / h 15 cm e gola in alluminio

Painted PVC PVC barnizado PVC peint

aluminium aluminio aluminium

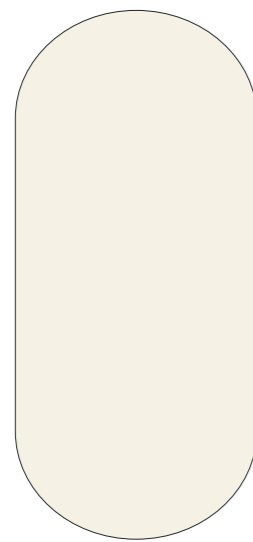

Bianco opaco



Titanio



Nero opaco

## Finiture scocche

Carcass finishes Acabados en estructuras Finitions caissons

### Nobilitato opaco tinta unita 18mm

Matte single colour melamine Melamina mate color liso Bois amélioré mat uni

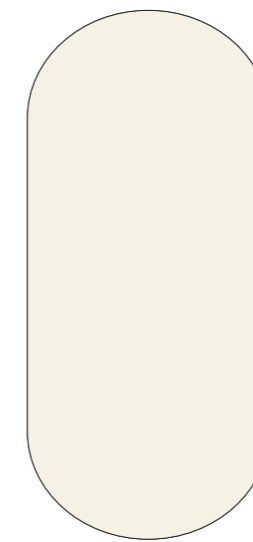

White



Rosè

# Tavoli

Tables Mesas Tables

## Plutone

Tavolo allungabile con prolunghe  
Extendable table complete with extensions.  
Mesa extensible con extensiones.  
Table allongeable avec rallonges.



## Marte

Tavolo allungabile con prolunghe  
Extendable table complete with extensions.  
Mesa extensible con extensiones.  
Table allongeable avec rallonges.



## Krono basic

Tavolo allungabile con prolunghe  
Extendable table complete with extensions.  
Mesa extensible con extensiones.  
Table allongeable avec rallonges.



**Finiture struttura** Fusto e gambe in metallo verniciato.  
Body and legs in painted metal.  
Estructura y patas de metal barnizado.  
Fût et pieds en métal verni.



**Finiture top** Piano in melaminico.  
Melamine top.  
Tablero de melamina.  
Plateau en mélaminé.



# Sedie e sgabelli

Chairs and stools Sillas y taburetes Chaises et tabourets

## Paola

Sedia Chair Silla Chaise



## Eva

Sedia Chair Silla Chaise



## Tata young

Sedia Chair Silla Chaise



## Tata young

Sgabello Stool Taburet Tabouret



**Finiture struttura** Struttura in metallo verniciato.  
Painted metal structure.  
Estructura de metal barnizado.  
Structure en métal verni.



**Finiture seduta** Seduta in polipropilene.  
Polypropylene seat.  
Asiento de polipropileno.  
Assise en polypropylène.



Concept and design  
Mama Studio

Product design  
Mama studio

Graphic design  
Mama Studio

3D images  
Mama studio

Copywriting  
Mama Studio

Printed by  
Antezza Tipografi

Printed in Italy - APRILE 2024



[stosa.it](http://stosa.it)

